

**BeiDou Navigation Satellite System
Signal In Space
Interface Control Document**

Open Service Signal B1I (Version 3.0)



China Satellite Navigation Office

February 2019

Table of Contents

1	Statement.....	1
2	Scope.....	1
3	BDS Overview.....	1
	3.1 Space Constellation.....	1
	3.2 Coordinate System.....	2
	3.3 Time System.....	3
4	Signal Specifications.....	4
	4.1 Signal Structure.....	4
	4.2 Signal Characteristics.....	4
	4.2.1 Carrier Frequency.....	4
	4.2.2 Modulation Mode.....	4
	4.2.3 Polarization Mode.....	4
	4.2.4 Carrier Phase Noise.....	5
	4.2.5 Received Power Levels on Ground.....	5
	4.2.6 Signal Multiplexing Mode.....	5
	4.2.7 Signal Bandwidth.....	5
	4.2.8 Spurious.....	5
	4.2.9 Signal Coherence.....	5
	4.2.10 Equipment Group Delay Differential.....	6
	4.3 Ranging Code Characteristics.....	6
5	Navigation Message.....	10

5.1	General	10
5.1.1	Navigation Message Classification	10
5.1.2	Navigation Message Information Type and Broadcasting	10
5.1.3	Data Error Correction Coding Mode	14
5.2	D1 Navigation Message	17
5.2.1	Secondary Code Modulated on D1	17
5.2.2	D1 Navigation Message Frame Structure	18
5.2.3	D1 Navigation Message Detailed Structure	19
5.2.4	D1 Navigation Message Content and Algorithm.....	25
5.3	D2 Navigation Message	47
5.3.1	D2 Navigation Message Frame Structure.....	47
5.3.2	D2 Navigation Message Detailed structure	47
5.3.3	D2 Navigation Message Content and Algorithm.....	72
6	Acronyms	84

1 Statement

China Satellite Navigation Office is responsible for the preparation, revision, distribution, and retention of BeiDou Navigation Satellite System Signal In Space Interface Control Document (hereinafter referred to as ICD), and reserves the right for final explanation of this ICD.

2 Scope

The construction and development of BeiDou Navigation Satellite System (BDS) is divided into three phases: BDS-1, BDS-2 and BDS-3 in sequence.

This document is a upgraded version of *BeiDou Navigation Satellite System Signal In Space Interface Control Document Open Service Signal (Version 2.1)*, and mainly defines the characteristics of the open service signal B1I transmitted from the BDS space segment to the BDS user segment. The B1I signal is transmitted by the BDS-2 and BDS-3 satellites including Medium Earth Orbit (MEO) satellites, Inclined GeoSynchronous Orbit (IGSO) satellites and Geostationary Earth Orbit (GEO) satellites for providing open services.

Note: The B2I signal is transmitted by all the BDS-2 satellites and also provides open services, which will be replaced by the B2a signal on the BDS-3 satellites. For more information about the B2I signal, please refer to *BeiDou Navigation Satellite System Signal In Space Interface Control Document Open Service Signal (Version 2.1)*.

3 BDS Overview

3.1 Space Constellation

The nominal space constellation of BDS-2 consists of 5 GEO satellites, 5 IGSO satellites and 4 MEO satellites. According to actual situation, spare

satellites may be deployed in orbit. The GEO satellites operate in orbit at an altitude of 35,786 kilometers and located at 58.75 °E, 80 °E, 110.5 °E, 140 °E, and 160 °E respectively. The IGSO satellites operate in orbit at an altitude of 35,786 kilometers and an inclination of the orbital planes of 55 degrees with reference to the equatorial plane. The MEO satellites operate in orbit at an altitude of 21,528 kilometers and an inclination of the orbital planes of 55 degrees with reference to the equatorial plane.

The nominal space constellation of BDS-3 consists of 3 GEO satellites, 3 IGSO satellites, and 24 MEO satellites. According to actual situation, spare satellites may be deployed in orbit. The GEO satellites operate in orbit at an altitude of 35,786 kilometers and are located at 80 °E, 110.5 °E, and 140 °E respectively. The IGSO satellites operate in orbit at an altitude of 35,786 kilometers and an inclination of the orbital planes of 55 degrees with reference to the equatorial plane. The MEO satellites operate in orbit at an altitude of 21,528 kilometers and an inclination of the orbital planes of 55 degrees with reference to the equatorial plane.

The BDS space constellation shall gradually take a transition from BDS-2's to BDS-3's and provides open services for users worldwide.

3.2 Coordinate System

The BeiDou Coordinate System is adopted by BDS, with the abbreviation as BDCS. The definition of BDCS is in accordance with the specifications of the International Earth Rotation and Reference System Service (IERS), and it is consistent with the definition of the China Geodetic Coordinate System 2000 (CGCS2000). BDCS and CGCS2000 have the same ellipsoid parameters. The definition of BDCS is as follows:

(1) Definition of origin, axis and scale

The origin is located at the Earth's center of mass. The Z-Axis is the

direction of the IERS Reference Pole (IRP). The X-Axis is the intersection of the IERS Reference Meridian (IRM) and the plane passing through the origin and normal to the Z-Axis. The Y-Axis, together with Z-Axis and X-Axis, constitutes a right-handed orthogonal coordinate system.

The length unit is the international system of units (SI) meter.

(2) Definition of the BDCS Ellipsoid

The geometric center of the BDCS Ellipsoid coincides with the Earth's center of mass, and the rotation axis of the BDCS Ellipsoid is the Z-Axis. The parameters of the BDCS Ellipsoid are shown in Table 3-1.

Table 3-1 Parameters of the BDCS Ellipsoid

No.	Parameter	Definition
1	Semi-major axis	$a=6378137.0 \text{ m}$
2	Geocentric gravitational constant	$\mu=3.986004418 \times 10^{14} \text{ m}^3/\text{s}^2$
3	Flattening	$f=1/298.257222101$
4	Earth's rotation rate	$\dot{\Omega}_e=7.2921150 \times 10^{-5} \text{ rad/s}$

3.3 Time System

The BeiDou navigation satellite system Time (BDT) is adopted by the BDS as time reference. BDT adopts the international system of units (SI) second as the base unit, and accumulates continuously without leap seconds. The start epoch of BDT is 00:00:00 on January 1, 2006 of Coordinated Universal Time (UTC). BDT connects with UTC via UTC (NTSC), and the deviation of BDT to UTC is maintained within 50 nanoseconds (modulo 1 second). The leap second information is broadcast in the navigation message.

4 Signal Specifications

4.1 Signal Structure

The B1I signal is composed of the carrier frequency, ranging code and navigation message. The ranging code and navigation message are modulated on carrier. The B1I signal is expressed as follows:

$$S_{\text{B1I}}^j(t) = A_{\text{B1I}} C_{\text{B1I}}^j(t) D_{\text{B1I}}^j(t) \cos(2\pi f_1 t + \varphi_{\text{B1I}}^j)$$

where,

Superscript j : satellite number;

A_{B1I} : amplitude of B1I;

C_{B1I} : ranging code of B1I;

D_{B1I} : data modulated on ranging code of B1I;

f_1 : carrier frequency of B1I;

φ_{B1I} : carrier initial phase of B1I.

4.2 Signal Characteristics

4.2.1 Carrier Frequency

The signal carrier frequencies on board of the same satellite shall be coherently derived from a common reference frequency source. The nominal frequency of the B1I signal is 1561.098 MHz.

4.2.2 Modulation Mode

The B1I signal is modulated by Binary Phase Shift Keying (BPSK).

4.2.3 Polarization Mode

The B1I signal shall be Right-Hand Circularly Polarized (RHCP).

4.2.4 Carrier Phase Noise

The phase noise spectral density of the un-modulated carrier will allow a third-order phase locked loop with 10 Hz one-sided noise bandwidth to track the carrier to an accuracy of 0.1 radians (RMS).

4.2.5 Received Power Levels on Ground

The minimum received power levels on ground of the B1I signals are specified to be -163dBW. They are measured at the output of a 0 dBi RHCP user receiving antenna (or 3dBi linearly polarized user receiving antenna) when the satellites are above a 5-degree elevation angle.

4.2.6 Signal Multiplexing Mode

The signal multiplexing mode is Code Division Multiple Access (CDMA).

4.2.7 Signal Bandwidth

The bandwidth of the B1I signal is 4.092 MHz (centered at carrier frequency of the B1I signal).

4.2.8 Spurious

The transmitted spurious signal is shall not exceed -50dBc.

4.2.9 Signal Coherence

(1) The random jitters of the ranging code phase differentials (including satellite equipment group delay differential) between B1I, B2I and B3I shall be less than 1ns (1σ).

(2) For the B1I signal, the random jitter of the initial phase differential between the ranging code and the corresponding carrier shall be less than 3° (1σ).

(relative to the carrier).

4.2.10 Equipment Group Delay Differential

The satellite equipment group delay is defined as the delay between the signal radiated output of a specific satellite (measured at the antenna phase center) and the output of that satellite's on-board frequency source. The equipment group delay of B3I is regarded as the reference equipment group delay which is included in the clock correction parameter a_0 broadcasted in the navigation message. The uncertainty of this delay shall be less than 0.5ns (1σ).

The equipment group delay differential between the B1I signal and the B3I signal is given in T_{GD1} . The equipment group delay differential between the B2I signal and the B3I signal is given in T_{GD2} . T_{GD1} and T_{GD2} are broadcast in the navigation message, the uncertainties of which shall be less than 1ns (1σ).

4.3 Ranging Code Characteristics

The chip rate of the B1I ranging code (hereinafter referred to as C_{B1I}) is 2.046 Mcps, and the code length is 2046 chips.

The C_{B1I} is generated by truncating a balanced Gold code with the last one chip. The balanced Gold code is generated by means of Modulo-2 addition of G1 and G2 sequences which are respectively derived from two 11-bit linear shift registers.

The generator polynomials for G1 and G2 are as follows:

$$G1(X)=1+X+X^7+X^8+X^9+X^{10}+X^{11}$$

$$G2(X)=1+X+X^2+X^3+X^4+X^5+X^8+X^9+X^{11}$$

The initial phases of G1 and G2 are:

G1: 01010101010;

G2: 01010101010.

The generator of C_{B1I} is shown in Figure 4-1.

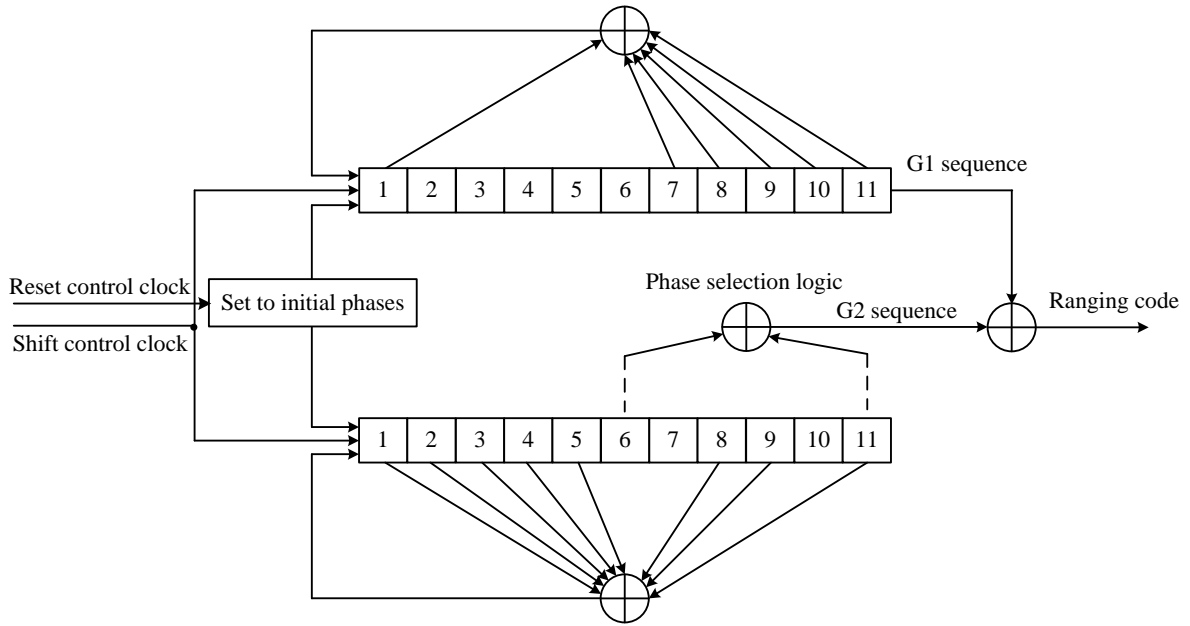

Figure 4-1 The generator of C_{B11}

The different phase shift of G2 sequence is accomplished by respective tapping in the shift register generating G2 sequence. By means of Modulo-2 addition of G2 with different phase shift and G1, a ranging code is generated for each satellite. The phase assignment of G2 sequence is shown in Table 4-1.

Table 4-1 Phase assignment of G2 sequence

SV ID	Satellite type	Ranging code number *	Phase assignment of G2 sequence
1	GEO satellite	1	1 ⊕ 3
2	GEO satellite	2	1 ⊕ 4
3	GEO satellite	3	1 ⊕ 5
4	GEO satellite	4	1 ⊕ 6
5	GEO satellite	5	1 ⊕ 8
6	MEO/IGSO satellite	6	1 ⊕ 9
7	MEO/IGSO satellite	7	1 ⊕ 10
8	MEO/IGSO satellite	8	1 ⊕ 11
9	MEO/IGSO satellite	9	2 ⊕ 7
10	MEO/IGSO satellite	10	3 ⊕ 4
11	MEO/IGSO satellite	11	3 ⊕ 5
12	MEO/IGSO satellite	12	3 ⊕ 6
13	MEO/IGSO satellite	13	3 ⊕ 8
14	MEO/IGSO satellite	14	3 ⊕ 9
15	MEO/IGSO satellite	15	3 ⊕ 10
16	MEO/IGSO satellite	16	3 ⊕ 11
17	MEO/IGSO satellite	17	4 ⊕ 5
18	MEO/IGSO satellite	18	4 ⊕ 6
19	MEO/IGSO satellite	19	4 ⊕ 8
20	MEO/IGSO satellite	20	4 ⊕ 9
21	MEO/IGSO satellite	21	4 ⊕ 10
22	MEO/IGSO satellite	22	4 ⊕ 11
23	MEO/IGSO satellite	23	5 ⊕ 6
24	MEO/IGSO satellite	24	5 ⊕ 8
25	MEO/IGSO satellite	25	5 ⊕ 9
26	MEO/IGSO satellite	26	5 ⊕ 10
27	MEO/IGSO satellite	27	5 ⊕ 11
28	MEO/IGSO satellite	28	6 ⊕ 8
29	MEO/IGSO satellite	29	6 ⊕ 9
30	MEO/IGSO satellite	30	6 ⊕ 10
31	MEO/IGSO satellite	31	6 ⊕ 11
32	MEO/IGSO satellite	32	8 ⊕ 9

SV ID	Satellite type	Ranging code number *	Phase assignment of G2 sequence
33	MEO/IGSO satellite	33	8 ⊕ 10
34	MEO/IGSO satellite	34	8 ⊕ 11
35	MEO/IGSO satellite	35	9 ⊕ 10
36	MEO/IGSO satellite	36	9 ⊕ 11
37	MEO/IGSO satellite	37	10 ⊕ 11
38	MEO/IGSO satellite	38	1 ⊕ 2 ⊕ 7
39	MEO/IGSO satellite	39	1 ⊕ 3 ⊕ 4
40	MEO/IGSO satellite	40	1 ⊕ 3 ⊕ 6
41	MEO/IGSO satellite	41	1 ⊕ 3 ⊕ 8
42	MEO/IGSO satellite	42	1 ⊕ 3 ⊕ 10
43	MEO/IGSO satellite	43	1 ⊕ 3 ⊕ 11
44	MEO/IGSO satellite	44	1 ⊕ 4 ⊕ 5
45	MEO/IGSO satellite	45	1 ⊕ 4 ⊕ 9
46	MEO/IGSO satellite	46	1 ⊕ 5 ⊕ 6
47	MEO/IGSO satellite	47	1 ⊕ 5 ⊕ 8
48	MEO/IGSO satellite	48	1 ⊕ 5 ⊕ 10
49	MEO/IGSO satellite	49	1 ⊕ 5 ⊕ 11
50	MEO/IGSO satellite	50	1 ⊕ 6 ⊕ 9
51	MEO/IGSO satellite	51	1 ⊕ 8 ⊕ 9
52	MEO/IGSO satellite	52	1 ⊕ 9 ⊕ 10
53	MEO/IGSO satellite	53	1 ⊕ 9 ⊕ 11
54	MEO/IGSO satellite	54	2 ⊕ 3 ⊕ 7
55	MEO/IGSO satellite	55	2 ⊕ 5 ⊕ 7
56	MEO/IGSO satellite	56	2 ⊕ 7 ⊕ 9
57	MEO/IGSO satellite	57	3 ⊕ 4 ⊕ 5
58	MEO/IGSO satellite	58	3 ⊕ 4 ⊕ 9
59	GEO satellite	59	3 ⊕ 5 ⊕ 6
60	GEO satellite	60	3 ⊕ 5 ⊕ 8
61	GEO satellite	61	3 ⊕ 5 ⊕ 10
62	GEO satellite	62	3 ⊕ 5 ⊕ 11
63	GEO satellite	63	3 ⊕ 6 ⊕ 9

* Range code number sequences 1 through 37 have priority to be used by the satellites to ensure the backward compatibility with the existing receivers.

5 Navigation Message

5.1 General

5.1.1 Navigation Message Classification

Navigation messages are formatted in D1 and D2 based on their rate and structure. The rate of D1 navigation message which is modulated with 1 kbps secondary code is 50 bps. D1 navigation message contains basic navigation information (fundamental navigation information of the broadcasting satellites, almanac information for all satellites as well as the time offsets from other systems); while D2 navigation message contains basic navigation and wide area differential information (the BDS integrity, differential and ionospheric grid information) and its rate is 500 bps.

The D1 navigation message is broadcast by the B1I signals of MEO/IGSO satellites. The D2 navigation message is broadcast by the B1I signals of GEO satellites.

5.1.2 Navigation Message Information Type and Broadcasting

The broadcasting schemes of the basic navigation information and wide area differential information are shown in Table 5-1. The detailed structure, bit allocations, contents and algorithms will be described in later chapters.

Table 5-1 Navigation message information contents and their broadcasting scheme

Message information content		No. of Bits	Broadcasting scheme	Basic navigation information, broadcast in every satellite
Preamble (Pre)		11	Occurring every subframe	
Subframe ID (FraID)		3		
Seconds of week (SOW)		20		
Basic navigation information of the broadcasting satellite	Week number (WN)	13	D1: broadcast in subframes 1, 2 and 3, repeated every 30 seconds. D2: broadcast in the first five words of pages 1~10 of subframe 1, repeated every 30 seconds. Updating rate: every 1 hour.	
	User range accuracy index (URAI)	4		
	Autonomous satellite health flag (SatH1)	1		
	Equipment group delay differential (T_{GD1}, T_{GD2})	10		
	Age of data, clock (AODC)	5		
	Clock correction parameters (t_{oc}, a_0, a_1, a_2)	74		
	Age of data, ephemeris (AODE)	5		
	Ephemeris parameters ($t_{oe}, \sqrt{A}, e, \omega, \Delta n, M_0, \Omega_0, \dot{\Omega}, i_0, IDOT, C_{uc}, C_{us}, C_{rc}, C_{rs}, C_{ic}, C_{is}$)	371		
Ionosphere model parameters ($\alpha_n, \beta_n, n=0\sim 3$)	64			
Page number (Pnum)		7	D1: broadcast in subframe 4 and subframe 5. D2: broadcast in subframe 5.	
Almanac	Identification of expanded almanacs (AmEpID)	2	D1: broadcast in pages 1~24 of subframe 4 and pages 1~6 of subframe 5. D2: broadcast in pages 37~60, 95~100 of subframe 5.	

Message information content		No. of Bits	Broadcasting scheme
	Almanac parameters ($t_{0a}, \sqrt{A}, e, \omega, M_0, \Omega_0, \dot{\Omega}, \delta_i, a_0, a_1, AmID$)	178	D1: broadcast in pages 1~24 of subframe 4 and pages 1~6 of subframe 5 for SV ID 1 through 30; broadcast in pages 11~23 of subframe 5 for SV ID 31 through 63 by using time-sharing method, and identified through AmEpID and AmID. D2: broadcast in pages 37~60, 95~100 of subframe 5 for SV ID 1 through 30; time-sharing broadcast in pages 103~115 of subframe 5 for SV ID 31 through 63 and identified by AmEpID and AmID. Updating period: less than 7 days.
	Week number of almanac (WN_a)	8	D1: broadcast in page 8 of subframe 5. D2: broadcast in page 36 of subframe 5. Updating period: less than 7 days.
	Health information for 30 satellites ($Hea_i, i=1\sim 43$)	9×43	D1: broadcast in pages 7~8 of subframe 5 for SV ID 1 through 30; broadcast in page 24 of subframe 5 for SV ID 31 through 63 by using time-sharing method, and identified through AmEpID and AmID. D2: broadcast in pages 35~36 of subframe 5 for SV ID 1 through 30; broadcast in page 116 of subframe 5 for SV ID 31 through 63 by using time-sharing method, and identified through AmEpID and AmID. Updating period: less than 7 days.
Time offsets from other systems	Time parameters relative to UTC ($A_{0UTC}, A_{1UTC}, \Delta t_{LS}, \Delta t_{LSF}, WN_{LSF}, DN$)	88	D1: broadcast in pages 9~10 of subframe 5. D2: broadcast in pages 101~102 of subframe 5. Updating period: less than 7 days.
	Time parameters relative to GPS time (A_{0GPS}, A_{1GPS})	30	
	Time parameters relative to Galileo time (A_{0Gal}, A_{1Gal})	30	
	Time parameters relative to GLONASS time (A_{0GLO}, A_{1GLO})	30	

Basic navigation information, broadcast in every satellite

Message information content		No. of Bits	Broadcasting scheme	Integrity and differential correction information and ionospheric grid information are broadcast by GEO satellites only.
Page number for basic navigation information (Pnum1)		4	D2: broadcast in pages 1~10 of subframe 1.	
Page number for integrity and differential correction information (Pnum2)		4	D2: broadcast in pages 1~6 of subframe 2.	
Satellite health flag for integrity and differential correction information (SatH2)		2	D2: broadcast in pages 1~6 of subframe 2. Updating rate: every 3 seconds.	
Identification of expanded BDS integrity and differential correction information (BDEpID)		2	D2: broadcast in pages 1~6 of subframe 4.	
BDS satellite identification of BDS integrity and differential correction information (BDID _i , i=1~63)		1×63	D2: broadcast in pages 1~6 of subframe 2 for SV ID 1 through 30; broadcast in pages 1~6 of subframe 4 for SV ID 31 through 63. Updating rate: every 3 seconds.	
Regional user range accuracy index (RURAI _i , i=1~24)		4×24	D2: broadcast in pages 1~6 of subframe 2, subframe 3 and subframe 4. Updating rate: every 18 seconds.	
BDS differential correction and differential correction integrity information	Equivalent clock correction (Δt_i , i=1~18)	13×24	D2: broadcast in pages 1~6 of subframe 2, subframe 3 and subframe 4. Updating rate: every 18 seconds.	
	User differential range error index (UDREI _i , i=1~18)	4×24	D2: broadcast in pages 1~6 of subframe 2 and subframe 4. Updating rate: every 3 seconds.	
Ionospheric grid information	Grid ionospheric vertical delay at grid point ($d\tau$)	9×320	D2: broadcast in pages 1~13, 61~73 of subframe 5. Updating rate: every 6 minutes.	
	Grid ionospheric vertical delay error index (GIVEI)	4×320		

5.1.3 Data Error Correction Coding Mode

The navigation message encoding involves both error control of BCH(15,11,1) and interleaving. The BCH code is 15 bits long with 11 information bits and error correction capability of 1 bit. The generator polynomial is $g(X)=1+X+X^4$.

The navigation message bits are grouped every 11 bits in sequence first. The serial/parallel conversion is made and the BCH(15,11,1) error correction encoding is performed in parallel. Parallel/serial conversion is then carried out for every two parallel blocks of BCH codes by turns of 1 bit to form an interleaved code of 30 bits length. The implementation is shown in Figure 5-1.

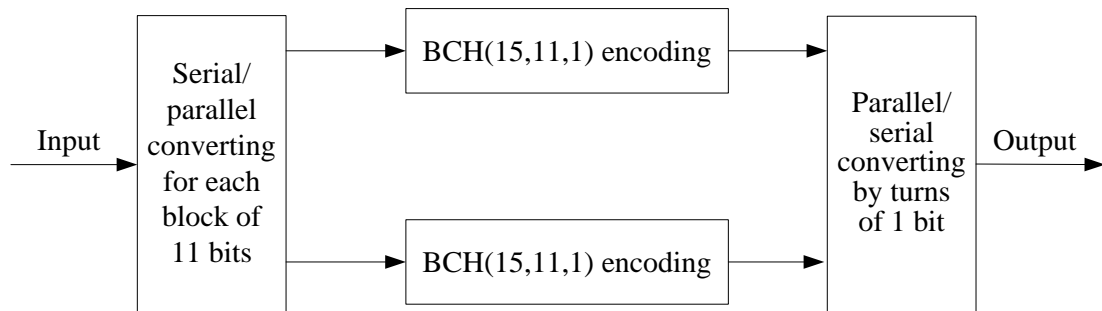

Figure 5-1 Error correction encoding and interleaving of down-link navigation message

The implementation of BCH (15,11,1) encoder is shown in Figure 5-2. Initially the four stages of the shift register are all reset to zero, Gate1 is on and Gate2 is off. The 11 bits of information block X are sent into a dividing circuit $g(X)$. Meantime the information bits are sent out of the encoder through gate “or” as the output. The dividing operation finishes when all the 11 bits have been sent in and then the states of the four register stages represent the parity check bits. Now switch Gate 1 off and Gate 2 on. The four parity check bits are shifted out of the encoder through gate “or” to form a 15 bits code in combination with the output 11 bits of information block. Then switch Gate1 on and Gate2 off and send in the next information block and the procedure above is repeated again.

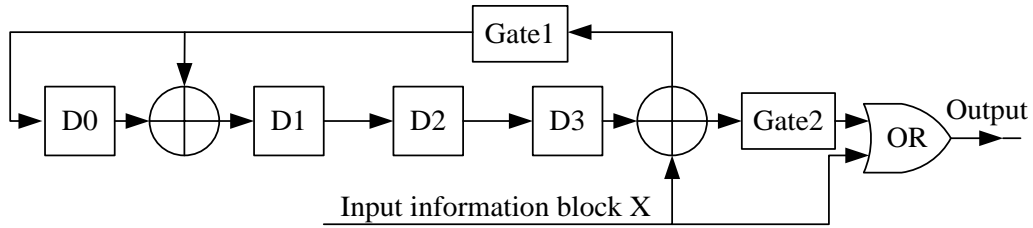

Figure 5-2 BCH(15, 11, 1) encoder

For the received navigation message by receivers near ground a serial/parallel conversion by turns of 1 bit is required first, followed by an error correction decoding of BCH(15,11,1) in parallel. Then a parallel/serial conversion is carried out for each 11 bits block to form a 22 bits information code in sequence. The processing is shown in Figure 5-3.

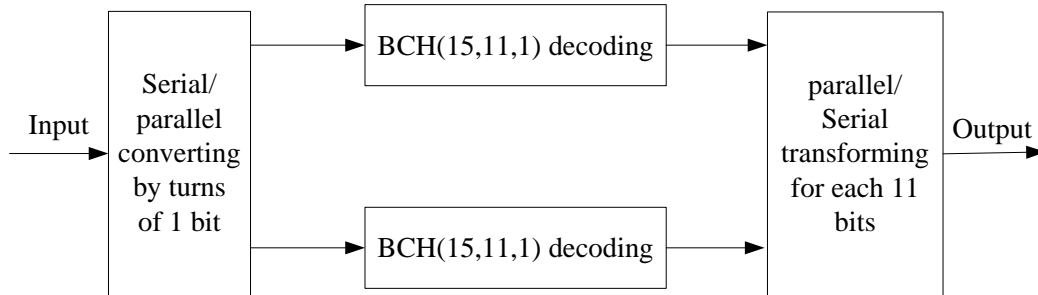

Figure 5-3 Processing of received down-link navigation message

The decoding logic of BCH(15,11,1) is shown in Figure 5-4. The initial states of the four register stages are all zeros. BCH codes are sent in bit by bit into a division circuit and a fifteen stages buffer simultaneously. When all fifteen bits of a BCH code are inputted, the ROM list circuit forms a fifteen-bit table based on the states D3, D2, D1 and D0 of the four register stages. Then the 15 bits in the table and 15 bits in the buffer are Modulo-2 added and an error corrected information code obtained is output. The ROM table list is shown in Table 5-2.

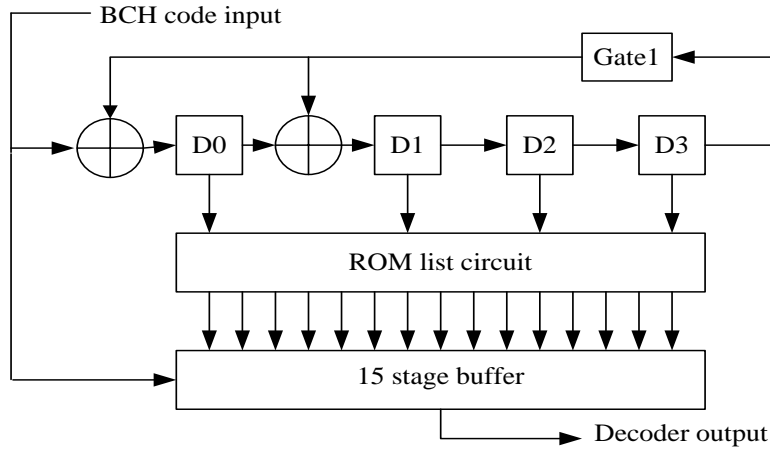

Figure 5-4 BCH(15,11,1) decoding logic

Table 5-2 ROM table list for error correction

$D_3D_2D_1D_0$	15 bits data for error correction
0000	0000000000000000
0001	0000000000000001
0010	0000000000000010
0011	0000000000010000
0100	0000000000000100
0101	0000001000000000
0110	0000000001000000
0111	0000100000000000
1000	0000000000001000
1001	1000000000000000
1010	0000010000000000
1011	0000000100000000
1100	0000000010000000
1101	0100000000000000
1110	0001000000000000
1111	0010000000000000

The interleaving pattern of 30 bits code is as follows:

X_1^1	X_2^1	X_1^2	X_2^2	...	X_1^{11}	X_2^{11}	P_1^1	P_2^1	P_1^2	P_2^2	P_1^3	P_2^3	P_1^4	P_2^4
---------	---------	---------	---------	-----	------------	------------	---------	---------	---------	---------	---------	---------	---------	---------

where, X_i^j is the information bit, subscript i stands for the bit in BCH code of block i and $i=1$ or 2 ; superscript j stands for the information bit j in block i and $j=1$ to 11 ; P_i^m is the check parity bit, subscript i stands for the bit in BCH code of block i and $i=1$ or 2 ; superscript m stands for the parity bit m in BCH code of block i and $m=1$ to 4 .

5.2 D1 Navigation Message

5.2.1 Secondary Code Modulated on D1 navigation message

For D1 navigation message of rate 50 bps, a secondary code of Neumann-Hoffman (NH) code is modulated on ranging code. The period of NH code is selected as long as the duration of a navigation message bit. The bit duration of NH code is the same as one period of the ranging code. Shown as in Figure 5-5, the duration of one navigation message bit is 20 milliseconds and the ranging code period is 1 millisecond. Thus the NH code (0000100110101001110) with length of 20 bits, rate 1 kbps and bit duration of 1 millisecond is adopted. It is modulo-2 added to the ranging code synchronously with navigation message bit.

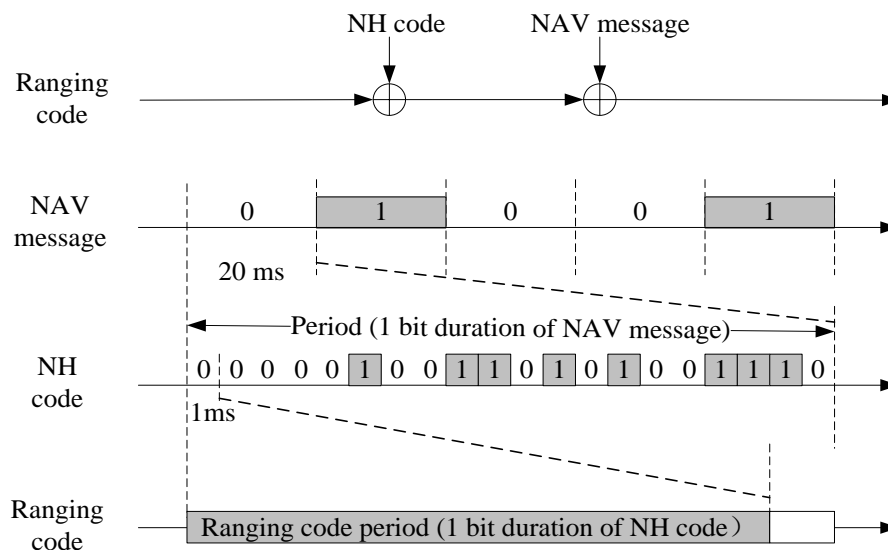

Figure 5-5 Secondary code and its timing

5.2.2 D1 Navigation Message Frame Structure

The navigation message in format D1 is structured in the superframe, frame and subframe. Every superframe has 36000 bits and lasts 12 minutes. Every superframe is composed of 24 frames (24 pages). Every frame has 1500 bits and lasts 30 seconds. Every frame is composed of 5 subframes. Every subframe has 300 bits and lasts 6 seconds. Every subframe is composed of 10 words. Every word has 30 bits and lasts 0.6 second.

Every word consists of navigation message data and parity bits. In the first word of every subframe, the first 15 bits is not encoded and the following 11 bits are encoded in BCH(15,11,1) for error correction. So there is only one group of BCH code contained and there are altogether 26 information bits in the word. For all the other 9 words in the subframe both BCH(15,11,1) encoding for error control and interleaving are involved. Each of the 9 words of 30 bits contains two blocks of BCH codes and there are altogether 22 information bits in it. (reference paragraph 5.1.3)

The frame structure in format D1 is shown in Figure 5-6.

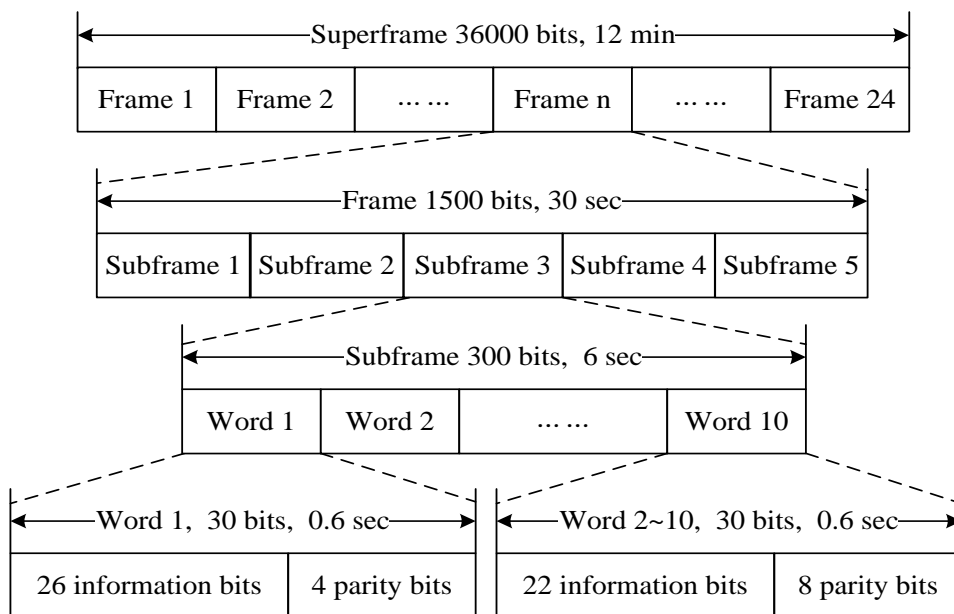

Figure 5-6 Frame structure of navigation message in format D1

5.2.3 D1 Navigation Message Detailed Structure

The main information contents of navigation message in format D1 are basic navigation information, including fundamental navigation information of the broadcasting satellites (seconds of week, week number, user range accuracy index, autonomous satellite health flag, ionospheric delay model parameters, satellite ephemeris parameters and their age, satellite clock correction parameters and their age and equipment group delay differential), almanac and BDT offsets from other systems (UTC and other navigation satellite systems).

The D1 frame structure and information contents are shown in Figure 5-7. The fundamental navigation information of the broadcasting satellite is in subframes 1, 2 and 3. The subframes 4 and 5 are divided into 24 pages and shall be used to broadcast almanac and time offsets from other systems for all the satellites.

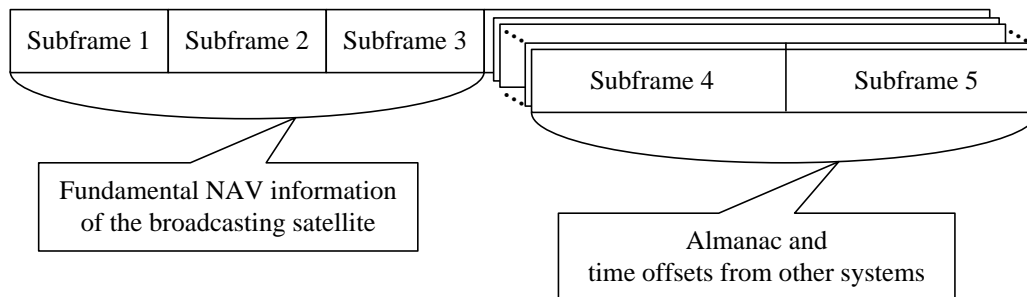

Figure 5-7 Information contents of navigation message in format D1

The bit allocations of format D1 are shown in Figure 5-8~5-11. Thereinto, pages 11~24 of subframe 5 are used to broadcast the expanded almanac information which contain the almanac parameters and the satellite health information for SV ID 31 through 63.

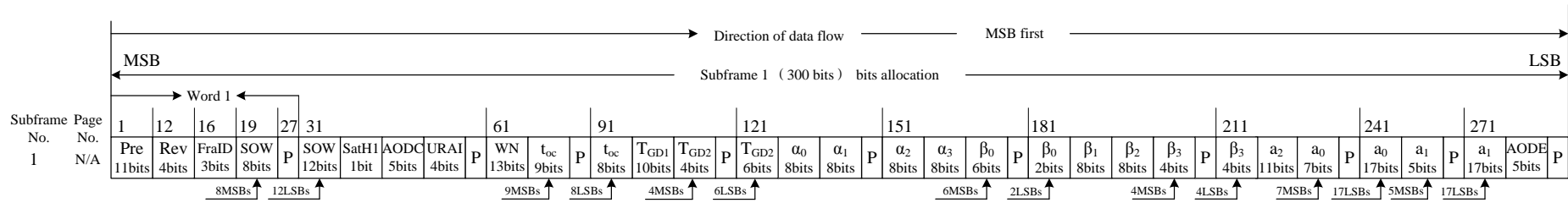

Figure 5-8 Bit allocation for subframe 1 in format D1

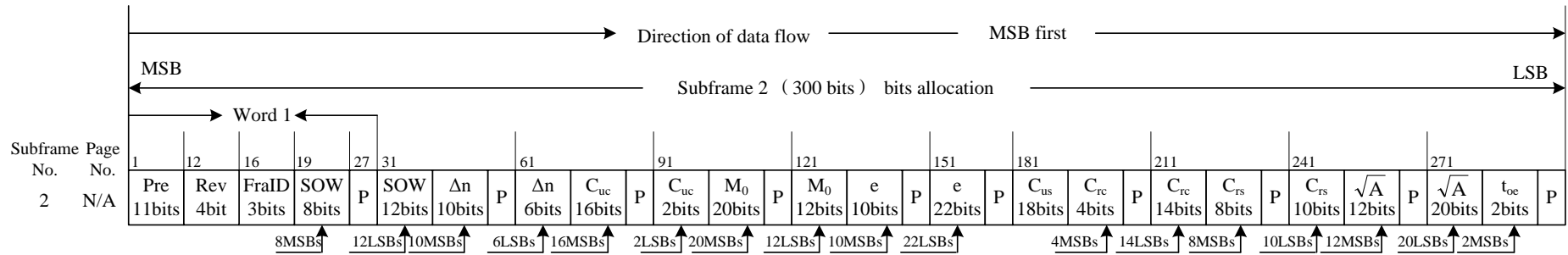
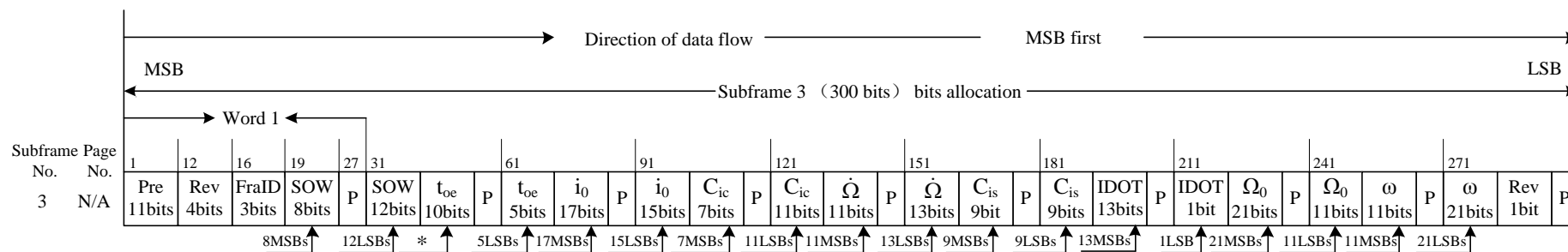

Figure 5-9 Bit allocation for subframe 2 in format D1



* These are data bits next to MSBs and before LSBs.

Figure 5-10 Bit allocation for subframe 3 in format D1

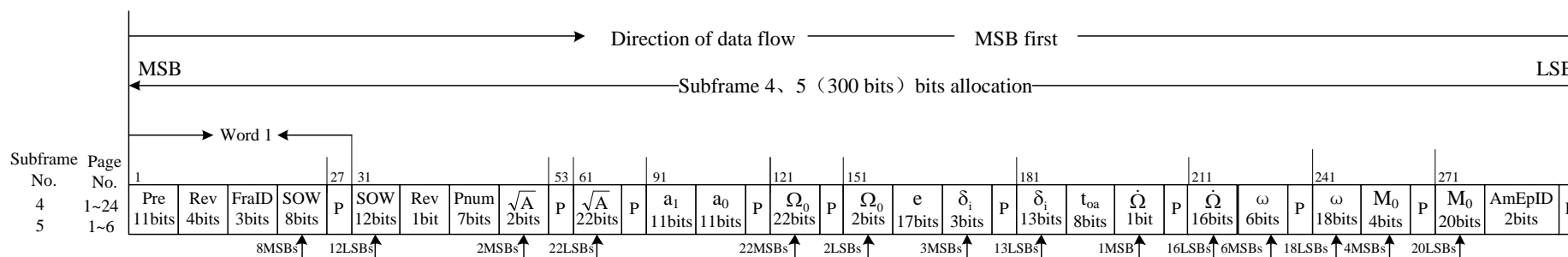

Figure 5-11-1 Bit allocation for pages 1 through 24 of subframe 4 and pages 1 through 6 of subframe 5 in format D1

(Note: AmEpID is the identification of expanded almanacs in format D1, and its specific definitions are given in section 5.2.4.14)

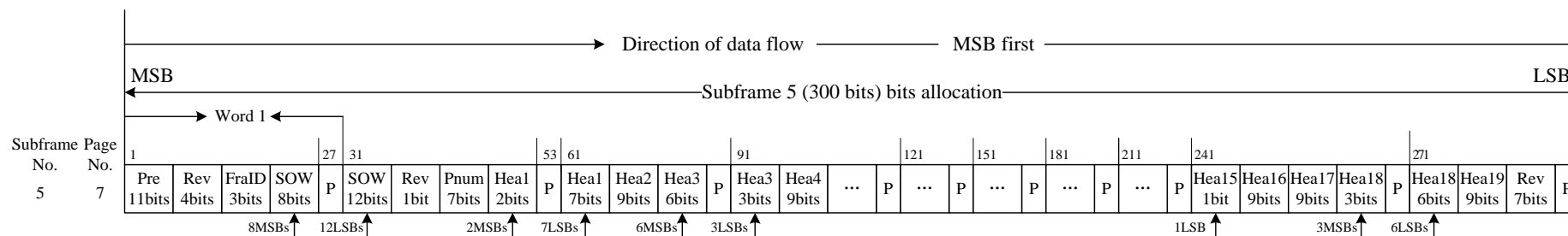

Figure 5-11-2 Bit allocation for page 7 of subframe 5 in format D1

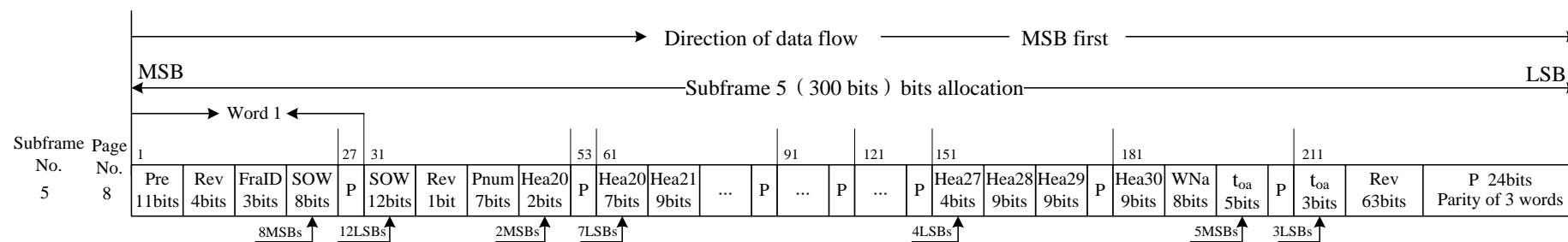

Figure 5-11-3 Bit allocation for page 8 of subframe 5 in format D1

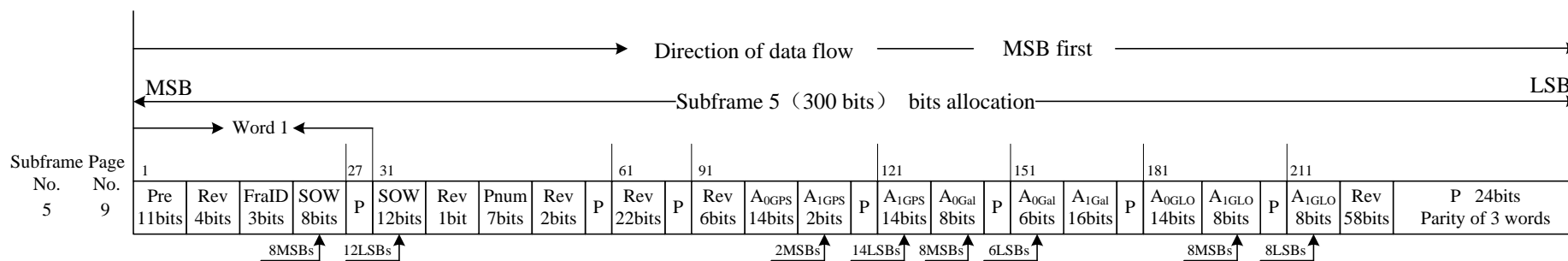

Figure 5-11-4 Bit allocation for page 9 of subframe 5 in format D1

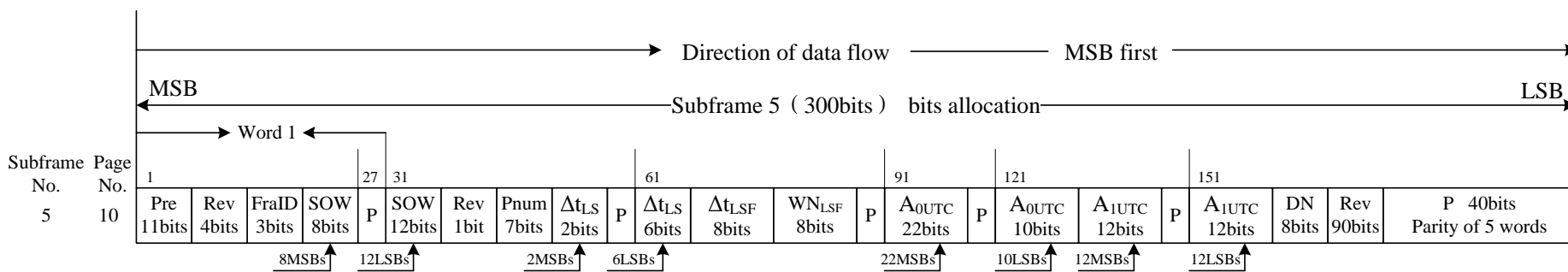

Figure 5-11-5 Bit allocation for page 10 of subframe 5 in format D1

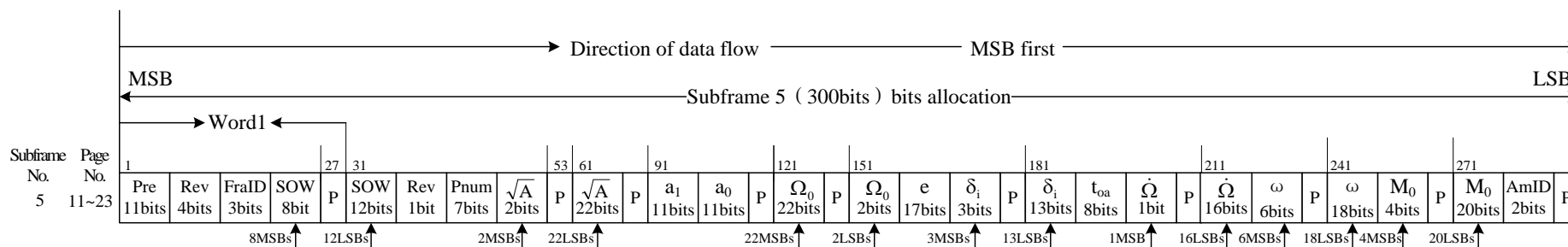

Figure 5-11-6 Bit allocation for page 11~23 of subframe 5 in format D1

(Note: When AmEpID is equal to “11”, pages 11 through 23 of subframe 5 are used to broadcast the almanac parameters. Otherwise, pages 11 through 23 of subframe 5 are defined as reserved pages, i.e., bits 51 through 300 of these pages are reserved.)

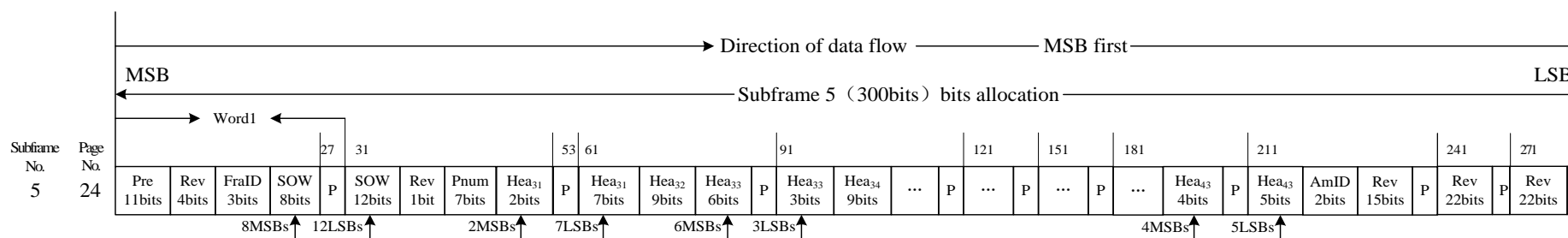

Figure 5-11-7 Bit allocation for page 24 of subframe 5 in format D1

(Note: When AmEpID is equal to “11”, page 24 of subframe 5 is used to broadcast the satellite health information. Otherwise, page 24 of subframe 5 is defined as a reserved page, i.e., bits 51 through 300 of this page are reserved.)

5.2.4 D1 Navigation Message Content and Algorithm

5.2.4.1 Preamble (Pre)

Bits 1 through 11 of each subframe are preamble (Pre) of “11100010010” from modified Barker code of 11 bits. SOW count occurs at the leading edge of the preamble first bit which is for time scale synchronization.

5.2.4.2 Subframe identification (FraID)

Bits 16, 17 and 18 of every subframe are for subframe identification (FraID). The detailed definitions are as follows:

Table 5-3 FraID definitions

Code	001	010	011	100	101	110	111
Identification of subframe	1	2	3	4	5	Rev	Rev

5.2.4.3 Seconds of Week (SOW)

Bits 19~26 and bits 31~42, altogether 20 bits of the each subframe are for seconds of week (SOW) which is defined as the number of seconds that have occurred since the last Sunday, 00:00:00 of BDT. The SOW count occurs at the leading edge of preamble first bit of the subframe.

5.2.4.4 Week Number (WN)

There are altogether 13 bits for week number (WN) which is the integral week count of BDT with the range of 0 through 8191. Week number count started from zero at 00:00:00 on Jan. 1, 2006 of BDT.

5.2.4.5 User Range Accuracy Index (URAI)

The user range accuracy (URA) is used to describe the signal-in-space accuracy in meters. There are 4 bits for the user range accuracy index (URAI). The range of URAI is from 0 to 15. See Table 5-4 for the corresponding relationship between URAI and URA.

Table 5-4 Corresponding relationship between URAI and URA

Code	URAI (N)	URA range (meters, 1σ)
0000	0	$0.00 < \text{URA} \leq 2.40$
0001	1	$2.40 < \text{URA} \leq 3.40$
0010	2	$3.40 < \text{URA} \leq 4.85$
0011	3	$4.85 < \text{URA} \leq 6.85$
0100	4	$6.85 < \text{URA} \leq 9.65$
0101	5	$9.65 < \text{URA} \leq 13.65$
0110	6	$13.65 < \text{URA} \leq 24.00$
0111	7	$24.00 < \text{URA} \leq 48.00$
1000	8	$48.00 < \text{URA} \leq 96.00$
1001	9	$96.00 < \text{URA} \leq 192.00$
1010	10	$192.00 < \text{URA} \leq 384.00$
1011	11	$384.00 < \text{URA} \leq 768.00$
1100	12	$768.00 < \text{URA} \leq 1536.00$
1101	13	$1536.00 < \text{URA} \leq 3072.00$
1110	14	$3072.00 < \text{URA} \leq 6144.00$
1111	15	$\text{URA} > 6144.00$

When an URAI is received by the user, the corresponding URA (X) is computed by the following equations:

$$\text{If } 0 \leq N < 6, X = 2^{N/2+1};$$

$$\text{If } 6 \leq N < 15, X = 2^{N-2};$$

If $N=15$, it means the satellite is in maneuver or there is no accuracy prediction;

If N=1, 3 and 5, X should be rounded to 2.8, 5.7, and 11.3 meters, respectively.

5.2.4.6 Autonomous Satellite Health flag (SatH1)

The autonomous satellite health flag (SatH1) occupies 1 bit. “0” means broadcasting satellite is good and “1” means not.

5.2.4.7 Ionospheric Delay Model Parameters (α_n, β_n)

There are 8 parameters, altogether 64 bits for ionospheric delay model. All the 8 parameters are in two’s complement. See Table 5-5 for details.

Table 5-5 Ionospheric delay model parameters

Parameter	No. of bits	Scale factor (LSB)	Units
α_0	8*	2^{-30}	s
α_1	8*	2^{-27}	s/ π
α_2	8*	2^{-24}	s/ π^2
α_3	8*	2^{-24}	s/ π^3
β_0	8*	2^{11}	s
β_1	8*	2^{14}	s/ π
β_2	8*	2^{16}	s/ π^2
β_3	8*	2^{16}	s/ π^3
* Parameters so indicated are two’s complement, with the sign bit (+ or -) occupying the MSB.			

The user computers the vertical ionospheric delay correction $I_z'(t)$ with the 8 parameters and Klobuchar model as follows:

$$I_z'(t) = \begin{cases} 5 \times 10^{-9} + A_2 \cos\left[\frac{2\pi(t - 50400)}{A_4}\right], & |t - 50400| < A_4/4 \\ 5 \times 10^{-9} & , |t - 50400| \geq A_4/4 \end{cases}$$

where, $I_z'(t)$ is the vertical ionospheric delay in seconds for B1I, t is the local time (range 0~86400 sec) for the place under the intersection point (M) of ionosphere and the direction from receiver to satellite. It is computed as:

$$t=(t_E+\lambda_M \times 43200/\pi)[\text{modulo } 86400]$$

where, t_E is the SOW in BDT computed by user. λ_M is geodetic longitude of the Earth projection of the ionospheric intersection point in radians.

A_2 is the amplitude of Klobuchar cosine curve in the day time computed from the α_n .

$$A_2 = \begin{cases} \sum_{n=0}^3 \alpha_n \left| \frac{\phi_M}{\pi} \right|^n, & A_2 \geq 0 \\ 0, & A_2 < 0 \end{cases}$$

A_4 is the period of cosine curve in seconds. It is computed from the β_n .

$$A_4 = \begin{cases} 172800, & A_4 \geq 172800 \\ \sum_{n=0}^3 \beta_n \left| \frac{\phi_M}{\pi} \right|^n, & 172800 > A_4 \geq 72000 \\ 72000, & A_4 < 72000 \end{cases}$$

where, ϕ_M is the geographic latitude of earth projection of the ionosphere intersection point in radians. The geographic latitude ϕ_M and longitude λ_M of the intersection point M are computed as:

$$\phi_M = \arcsin(\sin\phi_u \cdot \cos\psi + \cos\phi_u \cdot \sin\psi \cdot \cos A)$$

$$\lambda_M = \lambda_u + \arcsin\left(\frac{\sin\psi \cdot \sin A}{\cos\phi_M}\right)$$

where, ϕ_M and λ_M are in radians. ϕ_u is the user's geographic latitude in radians. A is the satellite azimuth from the user location in radians. ψ is the Earth's central angle in radians between the user location and ionospheric intersection point. It is computed as:

$$\psi = \frac{\pi}{2} - E - \arcsin\left(\frac{R}{R+h} \cdot \cos E\right)$$

where, R is the mean radius of the Earth (6378 km). E is the satellite elevation from the user's location in radians. h is the height of ionosphere (375 km).

$I_{B1I}(t)$ is defined as the ionospheric delay along the B1I propagation path (in seconds), which can be obtained from $I'_z(t)$ through the equation as follows:

$$I_{B1I}(t) = \frac{1}{\sqrt{1 - \left(\frac{R}{R+h} \cdot \cos E\right)^2}} \cdot I'_z(t)$$

The dual-frequency (B1I and B3I) user shall correct the ionospheric delay by applying the expression as follows:

$$PR = \frac{PR_{B3I} - k_{1,3}(f) \cdot PR_{B1I}}{1 - k_{1,3}(f)} + \frac{C \cdot k_{1,3}(f) \cdot T_{GD1}}{1 - k_{1,3}(f)}$$

where,

PR: pseudorange corrected for ionospheric effects;

PR_{B1I} : pseudorange measured on B1I(corrected by the satellite clock correction but not corrected by T_{GD1});

PR_{B3I} : pseudorange measured on B3I;

T_{GD1} : equipment group delay differential on B1I;

C: the light speed, and its value is 2.99792458×10^8 m/s.

5.2.4.8 Age of Data, Clock (AODC)

Age of data, clock (AODC) is updated at the start of each hour in BDT, and it is 5 bits long with definitions as follows:

Table 5-6 AODC definitions

AODC	Definition
< 25	Age of the satellite clock correction parameters in hours
25	Age of the satellite clock correction parameters is two days
26	Age of the satellite clock correction parameters is three days
27	Age of the satellite clock correction parameters is four days
28	Age of the satellite clock correction parameters is five days
29	Age of the satellite clock correction parameters is six days
30	Age of the satellite clock correction parameters is seven days
31	Age of the satellite clock correction parameters is over seven days

5.2.4.9 Clock Correction Parameters (t_{oc} , a_0 , a_1 , a_2)

Clock correction parameters are t_{oc} , a_0 , a_1 and a_2 in 74 bits altogether. t_{oc} is the reference time of clock parameters in seconds with the effective range of 0~604792. Other 3 parameters are two's complement.

The value of t_{oc} shall monotonically increase over the week and shall change if any of the clock parameters change. Normally, clock correction parameters are updated every one hour and at the start of BDT hours. The value of t_{oc} are integral points.

New navigation message will be uploaded when abnormality occurs, the clock correction parameters may be updated at non-integral points. At this time, t_{oc} will change and no longer be integral points.

When the value of t_{oc} has not been integral points (i.e., there has been an update at a non-integral point recently), if the clock correction parameters being updated at non-integral points again, t_{oc} will change

correspondingly to ensure it is different from the previous value.

Whether it is normal or not, clock correction parameters are always updated at the start of a superframe.

The definitions of clock correction parameters are listed in Table 5-7.

Table 5-7 Clock correction parameters

Parameter	No. of bits	Scale factor (LSB)	Effective range	Units
t_{oc}	17	2^3	604792	s
a_0	24*	2^{-33}	—	s
a_1	22*	2^{-50}	—	s/s
a_2	11*	2^{-66}	—	s/s ²

* Parameters so indicated are two's complement, with the sign bit (+ or -) occupying the MSB.

The system time computation is as follows:

The user is able to compute BDT at time of signal transmission as:

$$t = t_{sv} - \Delta t_{sv}$$

where, t is BDT in seconds at time of signal transmission; t_{sv} is the effective satellite ranging code phase time in seconds at time of signal transmission; Δt_{sv} is the offset of satellite ranging code phase time in seconds and is given by the equation:

$$\Delta t_{sv} = a_0 + a_1(t - t_{oc}) + a_2(t - t_{oc})^2 + \Delta t_r$$

where, t can be replaced by t_{sv} regardless of its sensitivity.

Δt_r is the correction term to relativistic effect with value of

$$\Delta t_r = F \cdot e \cdot \sqrt{A} \cdot \sin E_k$$

e is the orbit eccentricity, which is given in ephemeris of the broadcasting satellite;

\sqrt{A} is the square root of semi-major axis of satellite orbit, which is

given in ephemeris of the broadcasting satellite;

E_k is eccentric anomaly of satellite orbit, which is given in ephemeris of the broadcasting satellite;

$$F = -2\mu^{1/2}/C^2;$$

$\mu = 3.986004418 \times 10^{14} \text{ m}^3/\text{s}^2$, is the value of geocentric gravitational constant;

$$C = 2.99792458 \times 10^8 \text{ m/s}, \text{ is the light speed.}$$

5.2.4.10 Equipment Group Delay Differential (T_{GD1}, T_{GD2})

The equipment group delay differential (T_{GD1}, T_{GD2}) in the satellite is 10 bits long respectively. It is in two's complement with sign bit (+ or -) occupying MSB. Sign bit "0" means positive and "1" means negative. The scale factor is 0.1 and the unit is nanoseconds.

The single-frequency B1I user should make a further correction as follows:

$$(\Delta t_{sv})_{B1I} = \Delta t_{sv} - T_{GD1}$$

The single-frequency B2I user should make a further correction as follows:

$$(\Delta t_{sv})_{B2I} = \Delta t_{sv} - T_{GD2}$$

where, Δt_{sv} is the offset of satellite ranging code phase time in seconds and the detailed algorithm is defined in paragraph 5.2.4.9.

5.2.4.11 Age of Data, Ephemeris (AODE)

Age of data, ephemeris (AODE) is updated at the start of each hour in BDT, and it is 5 bits long with definitions as follows:

Table 5-8 AODE definitions

AODE	Definition
< 25	Age of the satellite ephemeris parameters in hours
25	Age of the satellite ephemeris parameters is two days
26	Age of the satellite ephemeris parameters is three days
27	Age of the satellite ephemeris parameters is four days
28	Age of the satellite ephemeris parameters is five days
29	Age of the satellite ephemeris parameters is six days
30	Age of the satellite ephemeris parameters is seven days
31	Age of the satellite ephemeris parameters is over seven days

5.2.4.12 Ephemeris Parameters (t_{oe} , \sqrt{A} , e , ω , Δn , M_0 , Ω_0 , $\dot{\Omega}$, i_0 , $IDOT$, C_{uc} , C_{us} , C_{rc} , C_{rs} , C_{ic} , C_{is})

The ephemeris parameters describe the satellite orbit during the curve fit interval, including 15 orbit parameters and an ephemeris reference time.

The value of t_{oe} shall monotonically increase over the week and shall change if any of the ephemeris parameters change. If t_{oe} changes then t_{oc} shall also change. Normally, ephemeris parameters are updated every hour and at the start of every BDT hour. The value of t_{oe} are integral points.

New navigation message will be uploaded when abnormality occurs, the ephemeris parameters may be updated at non-integral points. At this time, t_{oe} will change and no longer be integral points. When the value of t_{oe} has not been integral points (i.e., there has been an update at a

non-integral point recently), if the ephemeris parameters being updated at non-integral points again, t_{oe} will change correspondingly to ensure it is different from the previous value.

Whether it is normal or not, ephemeris parameters are always updated at the start of a superframe.

The definitions of ephemeris parameters are listed in Table 5-9.

Table 5-9 Ephemeris Parameters definitions

Parameter	Definition
t_{oe}	Ephemeris reference time
\sqrt{A}	Square root of semi-major axis
e	Eccentricity
ω	Argument of perigee
Δn	Mean motion difference from computed value
M_0	Mean anomaly at reference time
Ω_0	Longitude of ascending node of orbital of plane computed according to reference time
$\dot{\Omega}$	Rate of right ascension
i_0	Inclination angle at reference time
IDOT	Rate of inclination angle
C_{uc}	Amplitude of cosine harmonic correction term to the argument of latitude
C_{us}	Amplitude of sine harmonic correction term to the argument of latitude
C_{rc}	Amplitude of cosine harmonic correction term to the orbit radius
C_{rs}	Amplitude of sine harmonic correction term to the orbit radius
C_{ic}	Amplitude of cosine harmonic correction term to the angle of inclination
C_{is}	Amplitude of sine harmonic correction term to the angle of inclination

Characteristics of ephemeris parameters are shown in Table 5-10.

Table 5-10 Ephemeris parameters characteristics

Parameter	No. of Bits	Scale factor (LSB)	Effective Range	Units
t_{oe}	17	2^3	604792	s
\sqrt{A}	32	2^{-19}	8192	$m^{1/2}$
e	32	2^{-33}	0.5	—
ω	32*	2^{-31}	± 1	π
Δn	16*	2^{-43}	$\pm 3.73 \times 10^{-9}$	π/s
M_0	32*	2^{-31}	± 1	π
Ω_0	32*	2^{-31}	± 1	π
$\dot{\Omega}$	24*	2^{-43}	$\pm 9.54 \times 10^{-7}$	π/s
i_0	32*	2^{-31}	± 1	π
IDOT	14*	2^{-43}	$\pm 9.31 \times 10^{-10}$	π/s
C_{uc}	18*	2^{-31}	$\pm 6.10 \times 10^{-5}$	rad
C_{us}	18*	2^{-31}	$\pm 6.10 \times 10^{-5}$	rad
C_{rc}	18*	2^{-6}	± 2048	m
C_{rs}	18*	2^{-6}	± 2048	m
C_{ic}	18*	2^{-31}	$\pm 6.10 \times 10^{-5}$	rad
C_{is}	18*	2^{-31}	$\pm 6.10 \times 10^{-5}$	rad

* Parameters so indicated are two's complement, with the sign bit (+ or -) occupying the MSB.

The user receiver shall compute the satellite antenna phase center position in BDCS according to the received ephemeris parameters. The algorithms are listed in Table 5-11.

Table 5-11 Ephemeris algorithm for user

Computation	Description
$\mu = 3.986004418 \times 10^{14} \text{ m}^3/\text{s}^2$	Geocentric gravitational constant of BDCS
$\dot{\Omega}_e = 7.2921150 \times 10^{-5} \text{ rad/s}$	Earth's rotation rate of BDCS
$\pi = 3.1415926535898$	Ratio of a circle's circumference to its diameter
$A = (\sqrt{A})^2$	Computed semi-major axis
$n_0 = \sqrt{\frac{\mu}{A^3}}$	Computed mean motion (radians/sec)
$t_k = t - t_{oe}^*$	Computed time from ephemeris reference epoch
$n = n_0 + \Delta n$	Corrected mean motion
$M_k = M_0 + nt_k$	Computed mean anomaly
$M_k = E_k - e \sin E_k$	Kepler's Equation for Eccentric anomaly solved by iteration (radians)
$\begin{cases} \sin v_k = \frac{\sqrt{1-e^2} \sin E_k}{1-e \cos E_k} \\ \cos v_k = \frac{\cos E_k - e}{1-e \cos E_k} \end{cases}$	Computed true anomaly
$\phi_k = v_k + \omega$	Computed argument of latitude
$\begin{cases} \delta u_k = C_{us} \sin(2\phi_k) + C_{uc} \cos(2\phi_k) \\ \delta r_k = C_{rs} \sin(2\phi_k) + C_{rc} \cos(2\phi_k) \\ \delta i_k = C_{is} \sin(2\phi_k) + C_{ic} \cos(2\phi_k) \end{cases}$	Argument of latitude correction Radius correction Inclination correction
$u_k = \phi_k + \delta u_k$	Corrected Argument of latitude parameters
$r_k = A(1 - e \cos E_k) + \delta r_k$	Corrected radius
$i_k = i_0 + \text{IDOT} \cdot t_k + \delta i_k$	Corrected inclination
$\begin{cases} x_k = r_k \cos u_k \\ y_k = r_k \sin u_k \end{cases}$	Computed satellite positions in orbital plane

$\Omega_k = \Omega_0 + (\dot{\Omega} - \dot{\Omega}_e)t_k - \dot{\Omega}_e t_{oe}$ $\begin{cases} X_k = x_k \cos \Omega_k - y_k \cos i_k \sin \Omega_k \\ Y_k = x_k \sin \Omega_k + y_k \cos i_k \cos \Omega_k \\ Z_k = y_k \sin i_k \end{cases}$	<p>Corrected longitude of ascending node in BDCS; MEO/IGSO satellite coordinates in BDCS;</p>
$\Omega_k = \Omega_0 + \dot{\Omega} t_k - \dot{\Omega}_e t_{oe}$ $\begin{cases} X_{GK} = x_k \cos \Omega_k - y_k \cos i_k \sin \Omega_k \\ Y_{GK} = x_k \sin \Omega_k + y_k \cos i_k \cos \Omega_k \\ Z_{GK} = y_k \sin i_k \end{cases}$ $\begin{bmatrix} X_k \\ Y_k \\ Z_k \end{bmatrix} = R_Z(\dot{\Omega}_e t_k) R_X(-5^\circ) \begin{bmatrix} X_{GK} \\ Y_{GK} \\ Z_{GK} \end{bmatrix}$ <p>where,</p> $R_X(\varphi) = \begin{pmatrix} 1 & 0 & 0 \\ 0 & +\cos \varphi & +\sin \varphi \\ 0 & -\sin \varphi & +\cos \varphi \end{pmatrix}$ $R_Z(\varphi) = \begin{pmatrix} +\cos \varphi & +\sin \varphi & 0 \\ -\sin \varphi & +\cos \varphi & 0 \\ 0 & 0 & 1 \end{pmatrix}$	<p>Corrected longitude of ascending node in inertial coordinate system; GEO satellite coordinates in user-defined inertial system; GEO satellite coordinates in BDCS;</p>
<p>* In the equations, “t” is the time of signal transmission in BDT. “t_k” is the total time difference between t and ephemeris reference time t_{oe} after taking account of beginning or end of a week crossovers. That is, subtract 604800 seconds from t_k if t_k is greater than 302400, add 604800 seconds to t_k if t_k is less than -302400 seconds.</p>	

5.2.4.13 Page number (Pnum)

Bits 44 through 50, 7 bits altogether of subframe 4 and subframe 5 are the page numbers (Pnum). Both subframe 4 and subframe 5 have 24 pages (i.e., pages 1 through 24) which are identified through the page number (Pnum).

The almanac parameters of SV ID 1 through 24 are arranged in pages 1 through 24 of subframe 4. The almanac parameters of SV ID 25 through 30 are arranged in pages 1 through 6 of subframe 5. The page

number corresponds to the SV ID one by one. Furthermore, the almanac parameters of SV ID 31 through 43, 44 through 56, and 57 through 63 can be arranged in pages 11 through 23 of subframe 5 by using the time-sharing broadcasting scheme.

5.2.4.14 Identification of Expanded Almanacs (AmEpID)

AmEpID is the identification of the expanded almanac information, which has a length of 2 bits. AmEpID is provided to enables the user to detect whether pages 11 through 24 of subframe 5 are used to broadcast the expanded almanac information (i.e., the almanac parameters and the satellite health information of SV ID 31 through 63).

When AmEpID is equal to “11”, pages 11 through 23 of subframe 5 can be used to broadcast the almanac parameters for SV ID 31 through 63, and page 24 of subframe 5 is used to broadcast the satellite health information for SV ID 31 through 63. Otherwise, pages 11 through 24 of subframe 5 are reserved.

5.2.4.15 Almanac Parameters ($t_{oa}, \sqrt{A}, e, \omega, M_0, \Omega_0, \dot{\Omega}, \delta_i, a_0, a_1, AmID$)

Almanac parameters are updated within every 7 days.

Definitions, characteristics and user algorithms of almanac parameters are listed in Tables 5-12, 5-13, 5-14 and 5-15 respectively.

Table 5-12 Almanac parameters definitions

Parameter	Definition
t_{oa}	Almanac reference time
\sqrt{A}	Square root of semi-major axis
e	Eccentricity
ω	Argument of Perigee

M_0	Mean anomaly at reference time
Ω_0	Longitude of ascending node of orbital plane computed according to reference time
$\dot{\Omega}$	Rate of right ascension
δ_i	Correction of orbit reference inclination at reference time
a_0	Satellite clock bias
a_1	Satellite clock rate
AmID	Identification of time-sharing broadcasting

AmID has a length of 2 bits, and its value is effective when AmEpID is equal to “11”. AmID can be used to identify the expanded almanac information (i.e., the almanac parameters and the satellite health information of SV ID 31 through 63) which are time-sharing broadcasted in pages 11 through 24 of subframe 5.

The user shall use AmEpID first to determine whether pages 11 through 23 of subframe 5 are used to broadcast the almanac parameters. When AmEpID is equal to “11”, the user shall further use AmID to identify the almanac parameters of SV ID 31 through 63 in pages 11 through 23 of subframe 5; otherwise, the value of AmID is invalid and the user shall not use pages 11 through 23 of subframe 5. The broadcasting scheme for the almanac parameters of SV ID 31 through 63 is defined in Table 5-13.

Table 5-13 Broadcasting scheme for the almanac parameters of SV ID 31~63

AmEpID	AmID	Pnum	SV ID	
11	01	11~23	31~43	
	10	11~23	44~56	
	11		11~17	57~63
			18~23	Reserved
	00	11~23	Reserved	

Table 5-14 Almanac parameters characteristics

Parameter	No. of Bits	Scale factor (LSB)	Effective range	Units
t_{oa}	8	2^{12}	602112	s
\sqrt{A}	24	2^{-11}	8192	$m^{1/2}$
e	17	2^{-21}	0.0625	—
ω	24*	2^{-23}	± 1	π
M_0	24*	2^{-23}	± 1	π
Ω_0	24*	2^{-23}	± 1	π
$\dot{\Omega}$	17*	2^{-38}	—	π/s
δ_i	16*	2^{-19}	—	π
a_0	11*	2^{-20}	—	s
a_1	11*	2^{-38}	—	s/s

* Parameters so indicated are two's complement, with the sign bit (+ or -) occupying the MSB.

Table 5-15 Almanac algorithms for users

Computation	Description
$\mu = 3.986004418 \times 10^{14} \text{ m}^3/\text{s}^2$	Geocentric gravitational constant of BDCS
$\dot{\Omega}_e = 7.2921150 \times 10^{-5} \text{ rad/s}$	Earth's rotation rate of BDCS
$A = (\sqrt{A})^2$	Computed semi-major axis
$n_0 = \sqrt{\frac{\mu}{A^3}}$	Computed mean motion (rad/sec)
$t_k = t - t_{oa}^*$	Computed time from Almanac reference epoch
$M_k = M_0 + n_0 t_k$	Computed mean anomaly
$M_k = E_k - e \sin E_k$	Kepler's equation for eccentric anomaly by iteration (radians)
$\begin{cases} \sin v_k = \frac{\sqrt{1-e^2} \sin E_k}{1-e \cos E_k} \\ \cos v_k = \frac{\cos E_k - e}{1-e \cos E_k} \end{cases}$	Computed true anomaly

$\phi_k = v_k + \omega$	Computed argument of latitude
$r_k = A(1 - e \cos E_k)$	Corrected radius
$\begin{cases} x_k = r_k \cos \phi_k \\ y_k = r_k \sin \phi_k \end{cases}$	Computed satellite positions in orbital plane
$\Omega_k = \Omega_0 + (\dot{\Omega} - \dot{\Omega}_e)t_k - \dot{\Omega}_e t_{oa}$	Corrected longitude of ascending node
$i = i_0 + \delta_i^{**}$	Orbit inclination at reference time
$\begin{cases} X_k = x_k \cos \Omega_k - y_k \cos i \sin \Omega_k \\ Y_k = x_k \sin \Omega_k + y_k \cos i \cos \Omega_k \\ Z_k = y_k \sin i \end{cases}$	Computed GEO/MEO/IGSO satellite coordinates in BDCS
<p>* In the equations, “t” is the time of signal transmission in BDT. “t_k” is the total time offset between time t and Almanac reference time t_{oa} taking account of beginning or end of a week crossover. That is, subtract 604800 seconds from t_k if t_k is greater than 302400, add 604800 seconds to t_k if t_k is less than -302400.</p> <p>** For MEO/IGSO satellites, i₀=0.30 semi-circles; for GEO satellites, i₀=0.00.</p>	

Almanac time computation is as follows:

$$t = t_{sv} - \Delta t_{sv}$$

where, t is BDT in seconds at time of signal transmission; t_{sv} is the effective satellite ranging code phase time in seconds at time of signal transmission; Δt_{sv} is the offset of satellite ranging code phase time in seconds and is given by the equation:

$$\Delta t_{sv} = a_0 + a_1(t - t_{oa})$$

where, t can be replaced by t_{sv} regardless of its sensitivity. The almanac reference time t_{oa} is counted from the starting time of almanac week number (WN_a).

5.2.4.16 Almanac Week Number (WN_a)

Almanac week number (WN_a) of 8 bits is the BDT integer week count (Modulo 256) with effective range of 0 to 255.

5.2.4.17 Satellite Health Information (Hea_i, i=1~43)

The satellite health information (Hea_i) occupies 9 bits. The 9th bit indicates the satellite clock health flag, while the 8th bit indicates the B1I signal health status, the 7th bit indicates the B2I signal health status, the 6th bit indicates the B3I signal health status and the 2nd bit indicates the information health status. The definitions are in Table 5-16.

Table 5-16 Satellite health information definitions

Bit allocation	Information code	Health information definition
Bit 9 (MSB)	0	Satellite clock normal
	1	*
Bit 8	0	B1I signal normal
	1	B1I signal abnormal**
Bit 7	0	B2I signal normal
	1	B2I signal abnormal**
Bit 6	0	B3I signal normal
	1	B3I signal abnormal**
Bit 5~3	0	Reserved
	1	Reserved
Bit 2	0	Navigation message valid
	1	Navigation message invalid (IOD over limit)
Bit 1 (LSB)	0	Reserved
	1	Reserved

* The satellite clock is unavailable if the other 8 bits are all “0”; the satellite is in failure or permanently shut off if the last 8bits are all “1”; the definition is reserved if the other 8 bits are in other values.
 ** The signal power is 10 dB lower than nominal value.

Hea_i (i=1~30) correspond to the satellite health information of SV ID 1 through 30. By using time-sharing broadcasting scheme, Hea_i (i=31~43) correspond to the satellite health information of SV ID 31 through 43, 44 through 56, and 57 through 63.

The user shall use AmEpID first to determine whether page 24 of subframe 5 is used to broadcast the satellite health information. When AmEpID is equal to “11”, the user shall further use AmID to identify the satellite health information of SV ID 31 through 63 in page 24 of subframe 5; otherwise, the value of AmID is invalid and the user shall not use page 24 of subframe 5. The broadcasting scheme for the satellite health information of SV ID 31 through 63 is defined in Table 5-17.

Table 5-17 Broadcasting scheme for Hea_i (i=31~43)

AmEpID	AmID	Hea _i	SV ID
11	01	i=31~43	31~43
	10		44~56
	11	i=31~37	57~63
		i=38~43	Reserved
	00	i=31~43	Reserved

5.2.4.18 Time Parameters relative to UTC (A_{0UTC} , A_{1UTC} , Δt_{LS} , WN_{LSF} , DN , Δt_{LSF})

These parameters indicate the relationship between BDT and UTC. Definitions of the parameters are listed in Table 5-18.

Table 5-18 Parameters relative to UTC

Parameter	No. of bits	Scale factor(LSB)	Effective range	Units
A_{0UTC}	32*	2^{-30}	—	s
A_{1UTC}	24*	2^{-50}	—	s/s
Δt_{LS}	8*	1	—	s
WN_{LSF}	8	1	—	week
DN	8	1	6	day
Δt_{LSF}	8*	1	—	s

* Parameters so indicated are two's complement, with the sign bit (+ or -) occupying the MSB.

A_{0UTC} : BDT clock bias relative to UTC;

A_{1UTC} : BDT clock rate relative to UTC;

Δt_{LS} : Delta time due to leap seconds before the new leap second effective;

WN_{LSF} : Week number of the new leap second, and its value consist of eight bits which shall be a modulo 256 binary representation of the week number to which the DN is referenced. The absolute value of the difference between the untruncated WN and WN_{LSF} values shall not exceed 127.

DN: Day number of week of the new leap second;

Δt_{LSF} : Delta time due to leap seconds after the new leap second effective;

Conversion from BDT into UTC:

The broadcast UTC parameters, the WN_{LSF} and DN values make users compute UTC with error not greater than 1 microsecond.

Depending upon the relationship of the effectivity time of leap second event and user's current BDT, the following three different cases of UTC/BDT conversion exist.

1) Whenever the effectivity time indicated by the WN_{LSF} and the DN values is not in the past (relative to the user's present time), and the user's current time t_E is prior to $DN+2/3$, the UTC/BDT relationship is given by:

$$t_{UTC} = (t_E - \Delta t_{UTC})[\text{modulo } 86400], \text{ seconds}$$

$$\Delta t_{UTC} = \Delta t_{LS} + A_{0UTC} + A_{1UTC} \times t_E, \text{ seconds}$$

where, t_E is the SOW in BDT computed by user.

2) Whenever the user's current time t_E falls within the time span of $DN+2/3$ to $DN+5/4$, proper accommodation of leap second event with possible week number transition is provided by the following equation for UTC:

$$t_{UTC} = W[\text{modulo}(86400 + \Delta t_{LSF} - \Delta t_{LS})], \text{ seconds}$$

where,

$$W=(t_E - \Delta t_{UTC} - 43200)[\text{modulo } 86400] + 43200, \text{ seconds}$$

$$\Delta t_{UTC} = \Delta t_{LS} + A_{0OUT} + A_{1UTC} \times t_E, \text{ seconds}$$

3) Whenever the effectivity time of leap second event, as indicated by the WN_{LSF} and DN values, is in the past (relative to the user's current time), and the user's current time t_E is after $DN+5/4$, the UTC/BDT relationship is given by:

$$t_{UTC} = (t_E - \Delta t_{UTC})[\text{modulo } 86400], \text{ seconds}$$

where,

$$\Delta t_{UTC} = \Delta t_{LSF} + A_{0UTC} + A_{1UTC} \times t_E, \text{ seconds}$$

The parameter definitions are the same with those in case 1).

5.2.4.19 Time Parameters relative to GPS time (A_{0GPS}, A_{1GPS})

These parameters indicate the relationship between BDT and GPS time as in Table 5-19. (Not broadcast temporarily)

Table 5-19 Time parameters relative to GPS time

Parameter	No. of Bits	Scale factor (LSB)	Units
A_{0GPS}	14*	0.1	ns
A_{1GPS}	16*	0.1	ns/s
* Parameters so indicated are two's complement, with the sign bit (+ or -) occupying the MSB.			

A_{0GPS} : BDT clock bias relative to GPS time;

A_{1GPS} : BDT clock rate relative to GPS time.

The relationship between BDT and GPS time is as follows:

$$t_{GPS} = t_E - \Delta t_{GPS}$$

where, $\Delta t_{GPS} = A_{0GPS} + A_{1GPS} \times t_E$; t_E is the SOW in BDT computed by user.

5.2.4.20 Time Parameters relative to Galileo time(A_{0Gal}, A_{1Gal})

These parameters indicate the relationship between BDT and Galileo time as in Table 5-20. (Not broadcast temporarily)

Table 5-20 Time parameters relative to Galileo time

Parameter	No. of Bits	Scale factor (LSB)	Units
A_{0Gal}	14*	0.1	ns
A_{1Gal}	16*	0.1	ns/s

* Parameters so indicated are two's complement, with the sign bit (+ or -) occupying the MSB.

A_{0Gal} : BDT clock bias relative to Galileo system time;

A_{1Gal} : BDT clock rate relative to Galileo system time.

Relationship between BDT and Galileo system time is as follows:

$$t_{Gal} = t_E - \Delta t_{Gal}$$

where, $\Delta t_{Gal} = A_{0Gal} + A_{1Gal} \times t_E$; t_E is the SOW in BDT computed by user.

5.2.4.21 Time Parameters relative to GLONASS time (A_{0GLO} , A_{1GLO})

These parameters indicate the relationship between BDT and GLONASS time as in Table 5-21. (Not broadcast temporarily)

Table 5-21 Time parameters relative to GLONASS time

Parameter	No. of Bits	Scale factor (LSB)	Units
A_{0GLO}	14*	0.1	ns
A_{1GLO}	16*	0.1	ns/s

* Parameters so indicated are two's complement, with the sign bit (+ or -) occupying the MSB.

A_{0GLO} : BDT clock bias relative to GLONASS time;

A_{1GLO} : BDT clock rate relative to GLONASS time.

Relationship between BDT and GLONASS time is as follows:

$$t_{GLO} = t_E - \Delta t_{GLO}$$

where, $\Delta t_{GLO} = A_{0GLO} + A_{1GLO} \times t_E$; t_E is the SOW in BDT computed by user.

5.3 D2 Navigation Message

5.3.1 D2 Navigation Message Frame Structure

The navigation message in format D2 is structured with superframe, frame and subframe. Every superframe is 180000 bits long, lasting 6 minutes. Every superframe is composed of 120 frames each with 1500 bits and lasting 3 seconds. Every frame is composed of 5 subframes, each with 300 bits and lasting 0.6 second. Every subframe is composed of 10 words, each with 30 bits and lasting 0.06 second.

Every word is composed of navigation message data and parity bits. The first 15 bits in word 1 of every subframe is not encoded, and the last 11 bits is encoded in BCH(15,11,1) for error correction. For the other 9 words of the subframe both BCH(15,11,1) encoding and interleaving are involved. Thus there are 22 information bits and 8 parity bits in each word. See Figure 5-12 for the detailed structure.

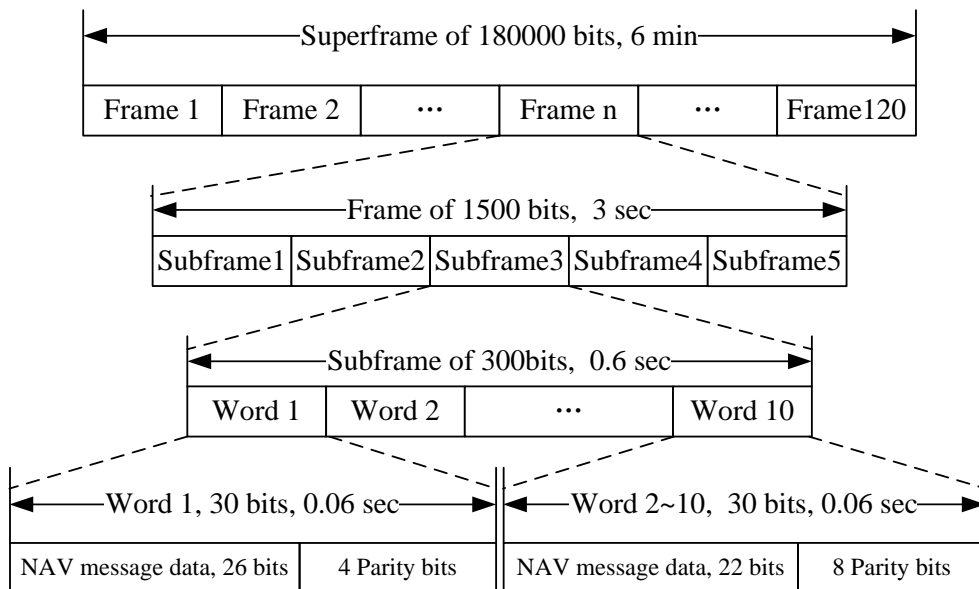

Figure 5-12 Structure of navigation message in format D2

5.3.2 D2 Navigation Message Detailed structure

Information in format D2 includes: the basic navigation information

of the broadcasting satellite, almanac, time offset from other systems, integrity and differential correction information of BDS and ionospheric grid information as shown in Figure 5-13. The subframe 1 shall be subcommutated 10 times via 10 pages. The subframe 2, subframe 3 and subframe 4 shall be subcommutated 6 times each via 6 pages. The subframe 5 shall be subcommutated 120 times via 120 pages.

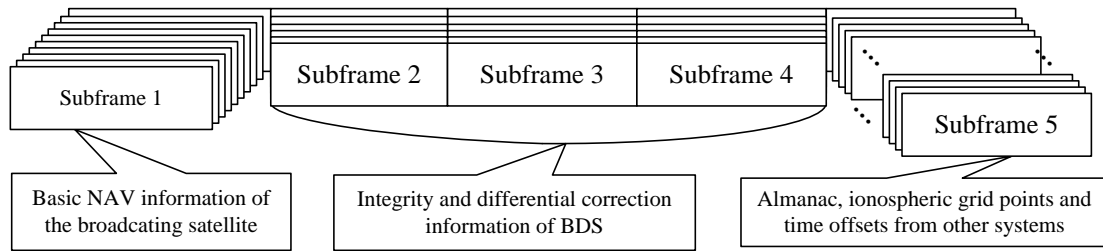

Figure 5-13 Information contents of navigation message in format D2

The bit allocation for each subframe in format D2 is shown in Figures 5-14 through 5-18. Thereinfo, pages 1 through 6 of subframe 4 are used to broadcast the expanded BDS integrity and differential correction information, pages 103 through 116 of subframe 5 are used to broadcast the expanded almanac information, and the 150 LSBs of pages 1 through 10 in subframe 1, pages 14 through 34, pages 74 through 94 and pages 117 through 120 of subframe 5 are reserved.

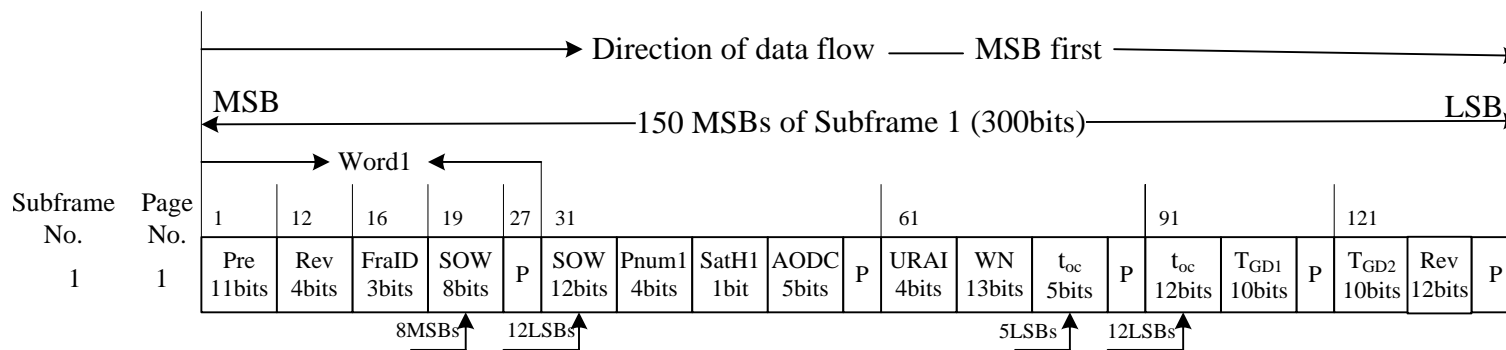

Figure 5-14-1 Bit allocation for 150 MSBs of page 1 of subframe 1 in format D2

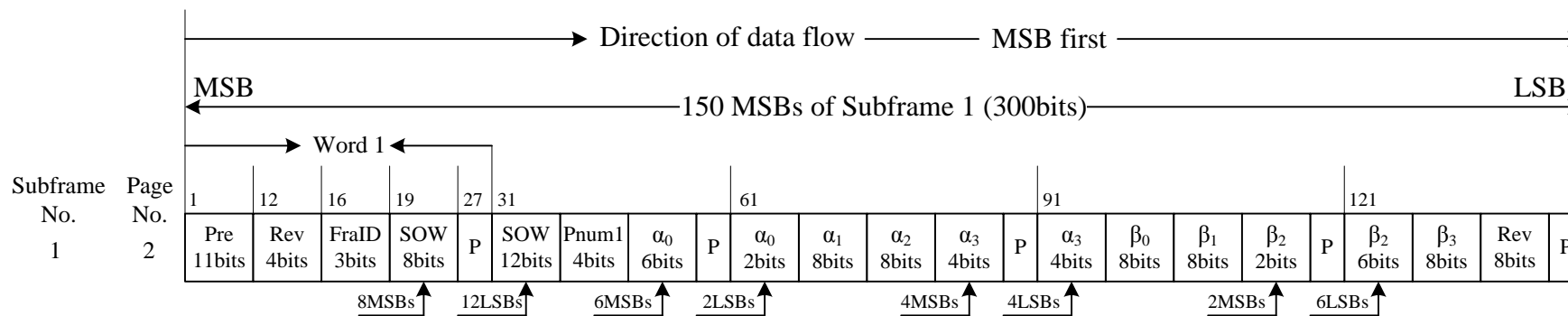

Figure 5-14-2 Bit allocation for 150 MSBs of page 2 of subframe 1 in format D2

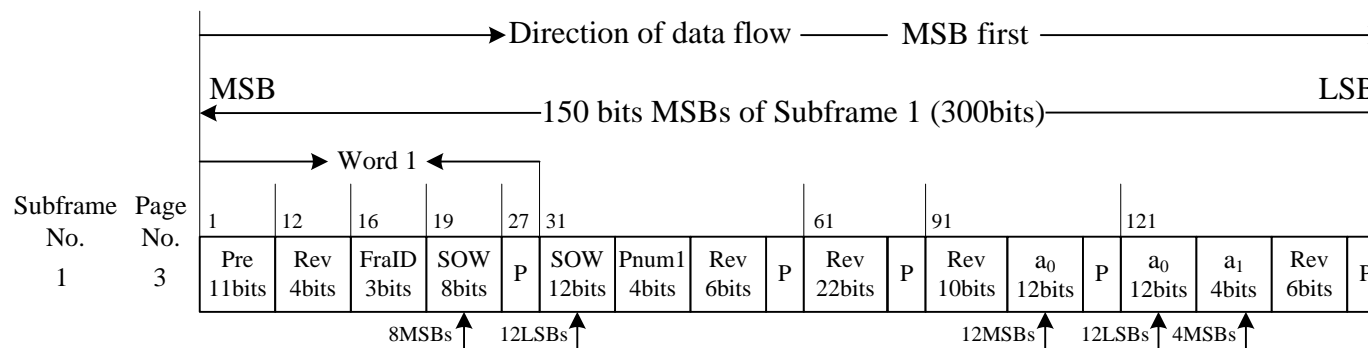
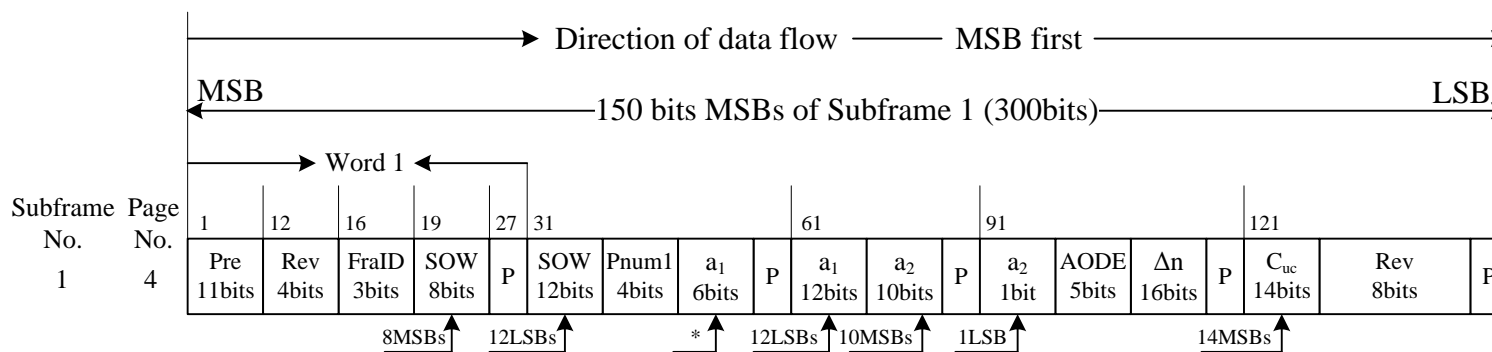
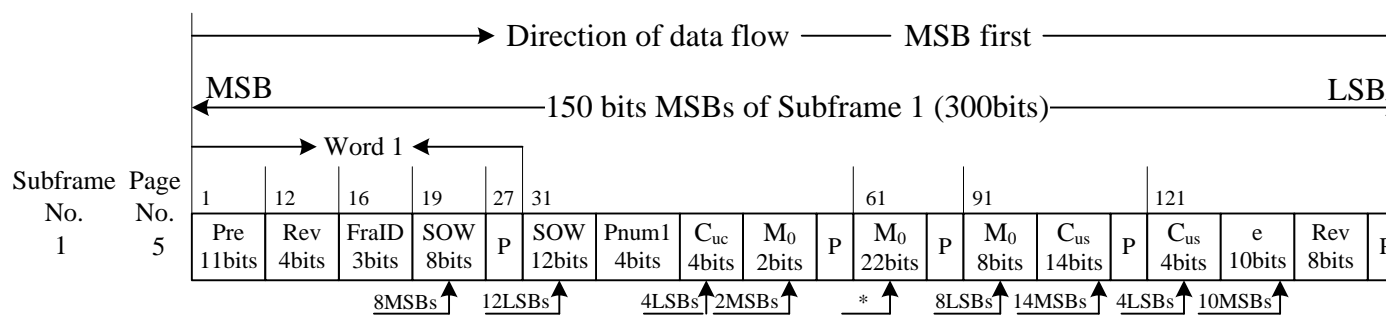

Figure 5-14-3 Bit allocation for 150 MSBs of page 3 of subframe 1 in format D2



* These are data bits next to MSBs and before LSBs.

Figure 5-14-4 Bit allocation for 150 MSBs of page 4 of subframe 1 in format D2



* These are data bits next to MSBs and before LSBs.

Figure 5-14-5 Bit allocation for 150 MSBs of page 5 of subframe 1 in format D2

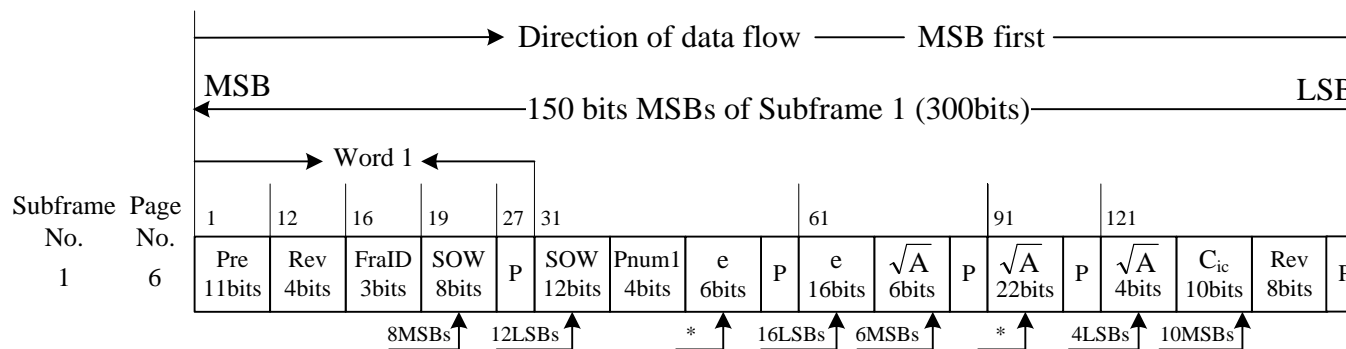

* These are data bits next to MSBs and before LSBs.

Figure 5-14-6 Bit allocation for 150 MSBs of page 6 of subframe 1 in format D2

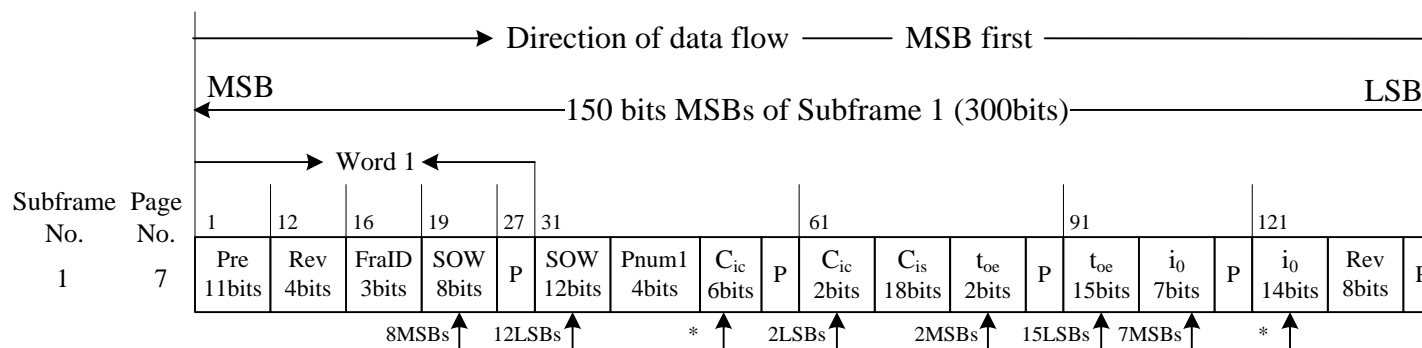

* These are data bits next to MSBs and before LSBs.

Figure 5-14-7 Bit allocation for 150 MSBs of page 7 of subframe 1 in format D2

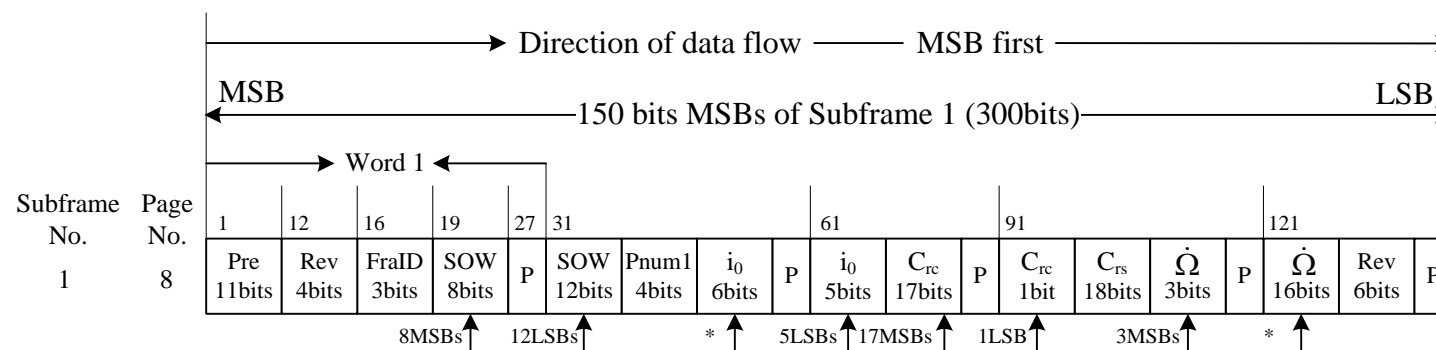

* These are data bits next to MSBs and before LSBs.

Figure 5-14-8 Bit allocation for 150 MSBs of page 8 of subframe 1 in format D2

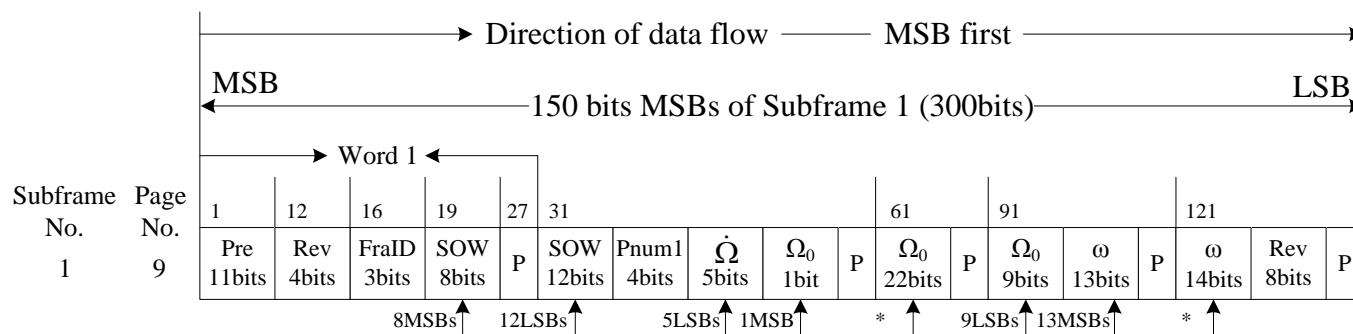

* These are data bits next to MSBs and before LSBs.

Figure 5-14-9 Bit allocation for 150 MSBs of page 9 of subframe 1 in format D2

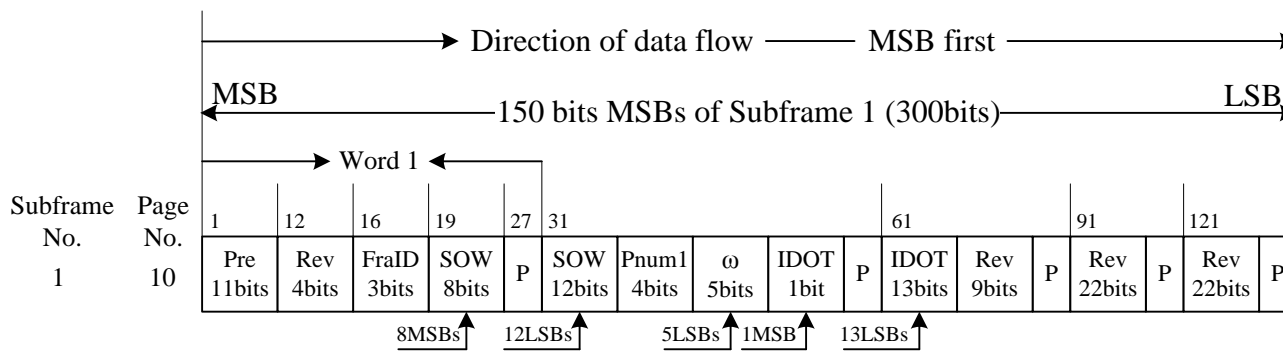

Figure 5-14-10 Bit allocation for 150 MSBs of page 10 of subframe 1 in format D2

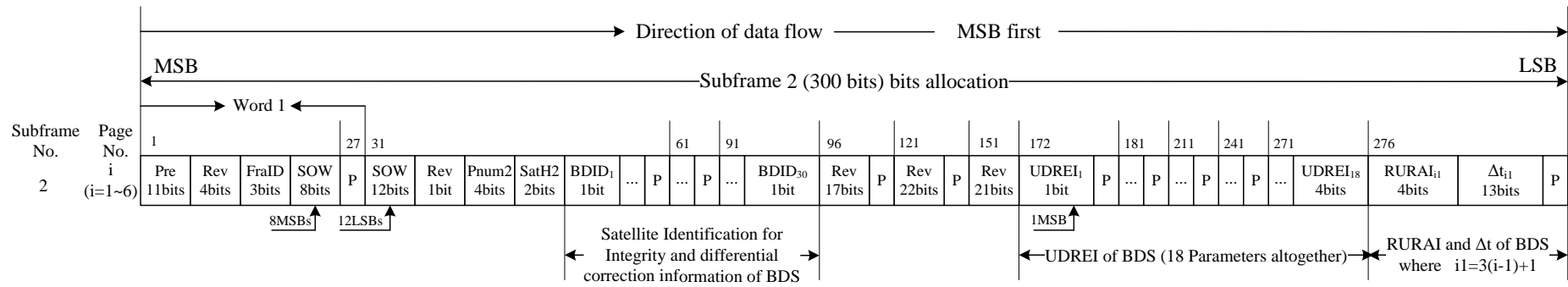

Figure 5-15 Bit allocation for subframe 2 in format D2

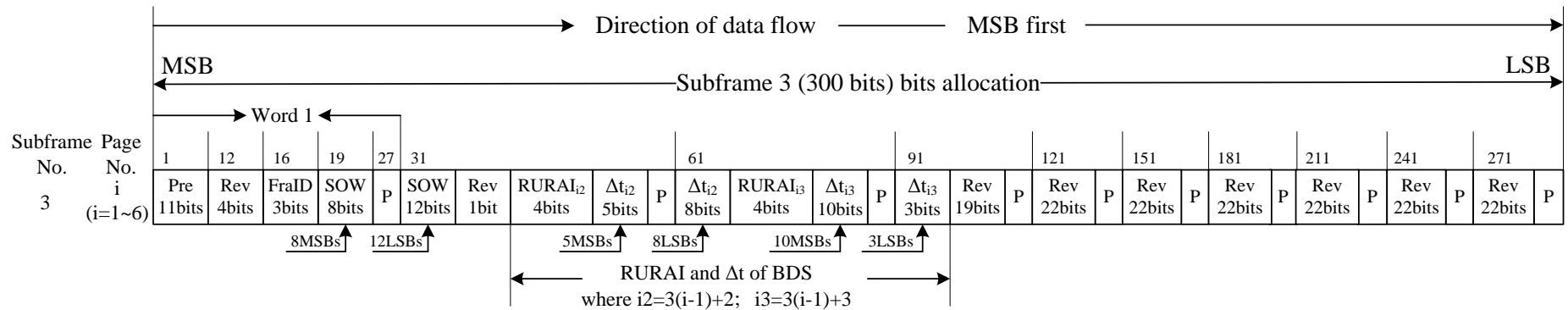

Figure 5-16 Bit allocation for subframe 3 in format D2

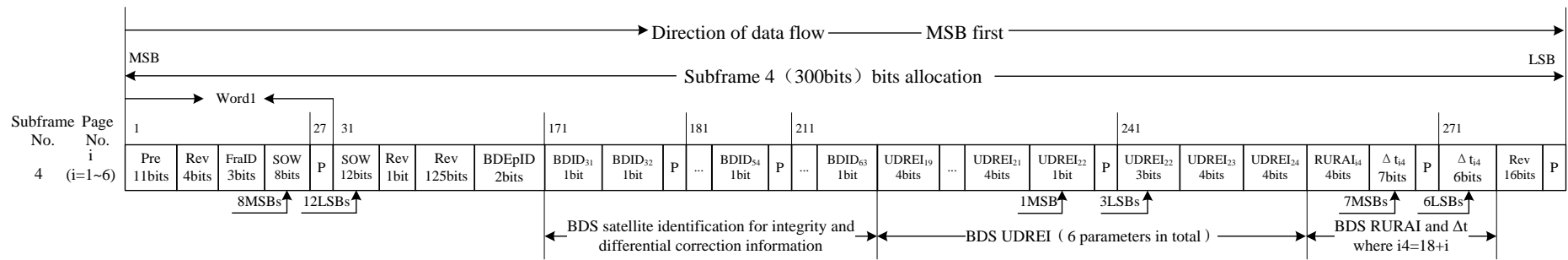

Figure 5-17 Bit allocation for subframe 4 in format D2

(Note: When BDEpID is equal to “11”, pages 1 through 6 of subframe 4 are used to broadcast the expanded BDS integrity and differential correction information. Otherwise, bits 171 through 300 of these pages are reserved.)

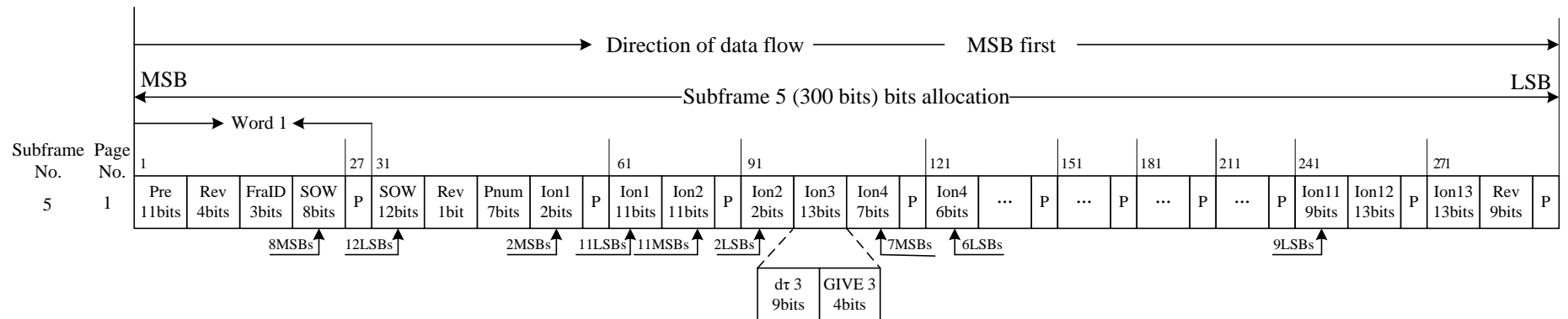

Figure 5-18-1 Bit allocation for page 1 of subframe 5 in format D2

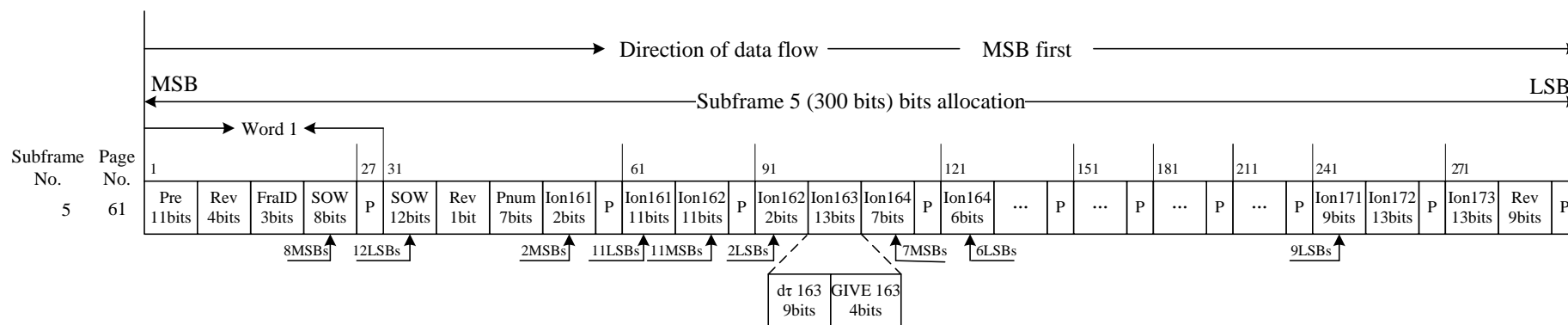

Figure 5-18-2 Bit allocation for page 61 of subframe 5 in format D2

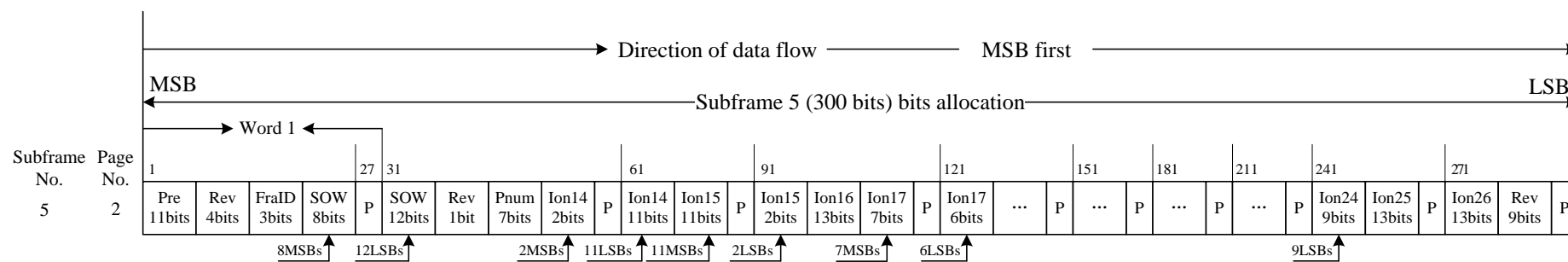

Figure 5-18-3 Bit allocation for page 2 of subframe 5 in format D2

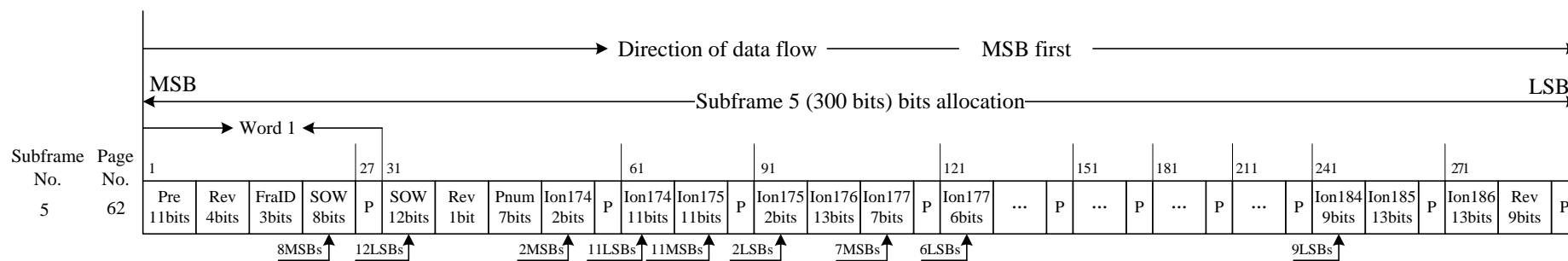

Figure 5-18-4 Bit allocation for page 62 of subframe 5 in format D2

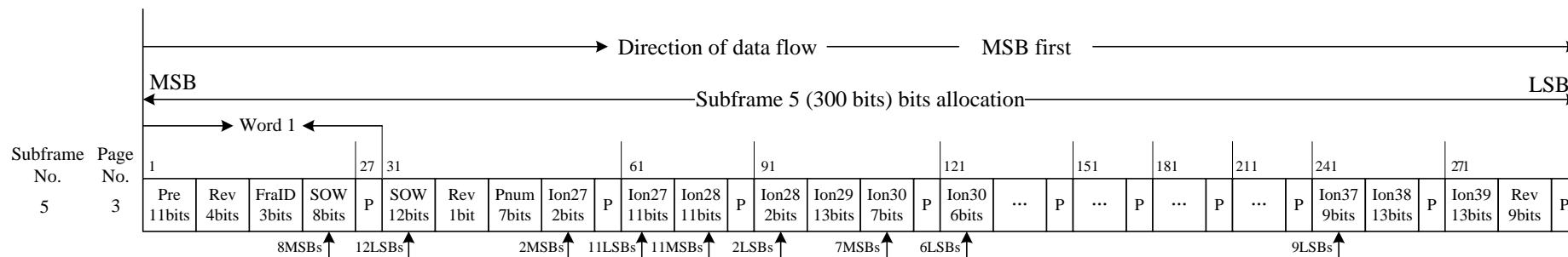

Figure 5-18-5 Bit allocation for page 3 of subframe 5 in format D2

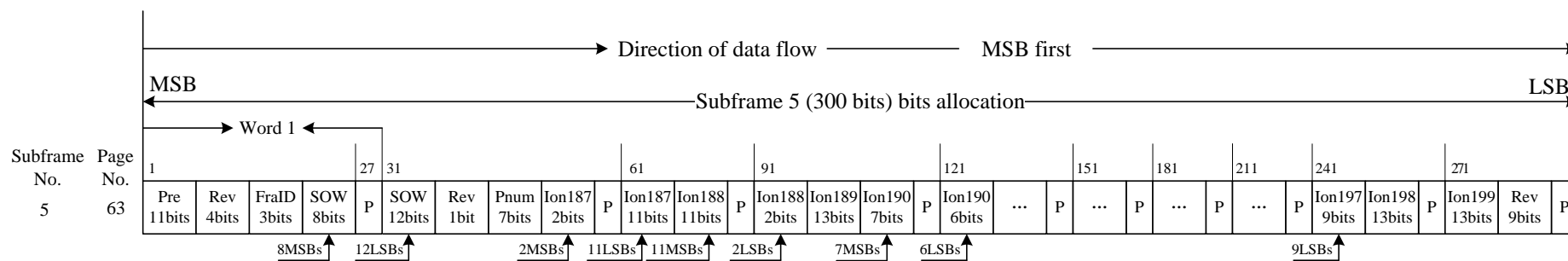

Figure 5-18-6 Bit allocation for page 63 of subframe 5 in format D2

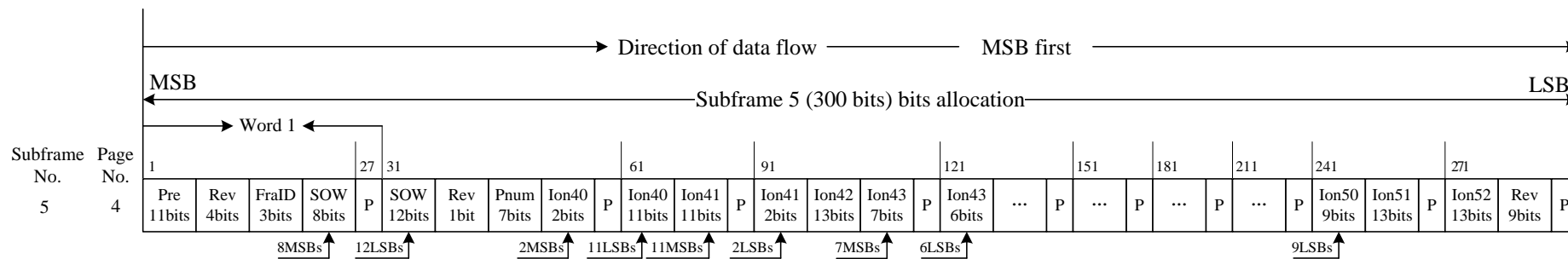

Figure 5-18-7 Bit allocation for page 4 of subframe 5 in format D2

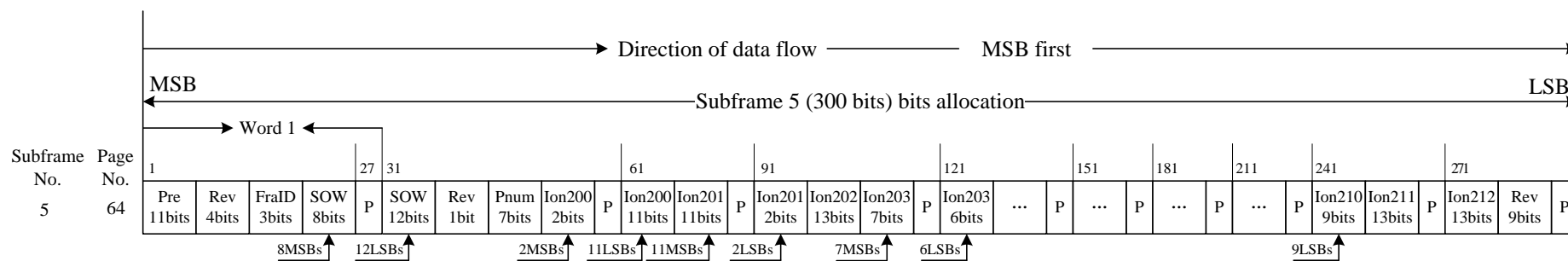

Figure 5-18-8 Bit allocation for page 64 of subframe 5 in format D2

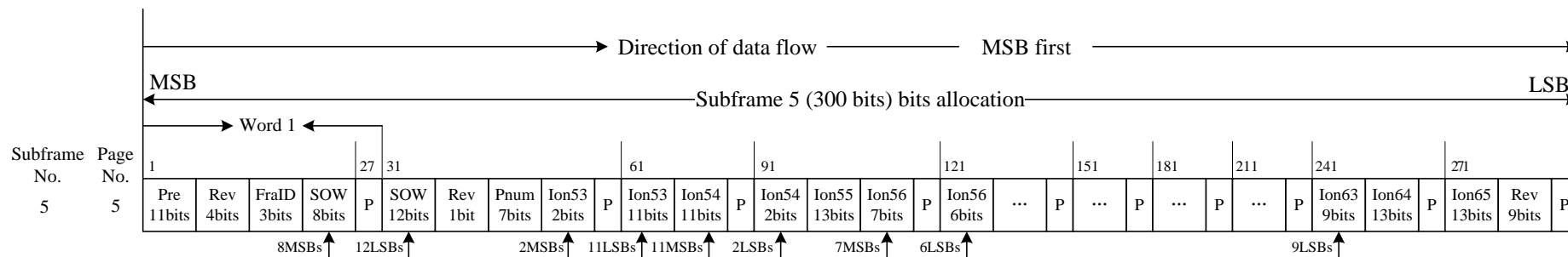

Figure 5-18-9 Bit allocation for page 5 of subframe 5 in format D2

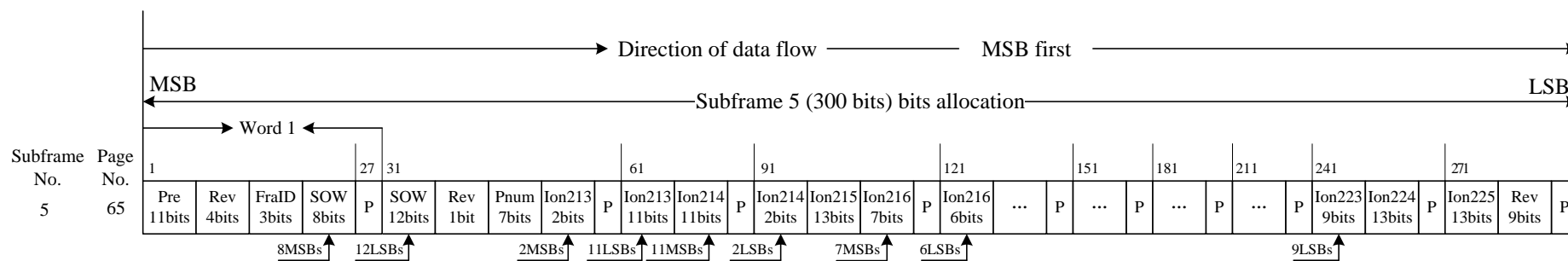

Figure 5-18-10 Bit allocation for page 65 of subframe 5 in format D2

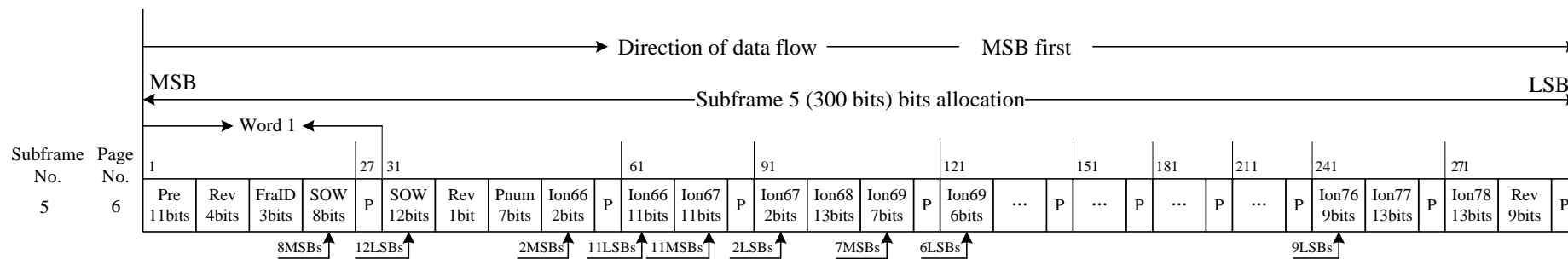

Figure 5-18-11 Bit allocation for page 6 of subframe 5 in format D2

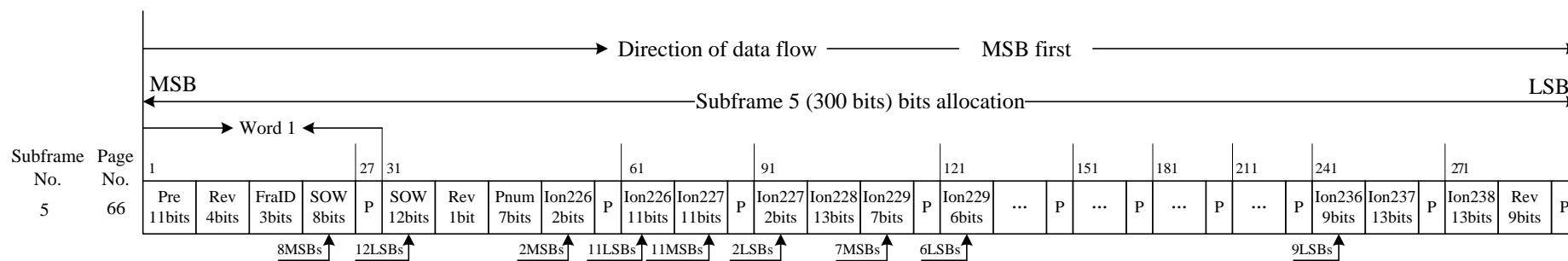

Figure 5-18-12 Bit allocation for page 66 of subframe 5 in format D2

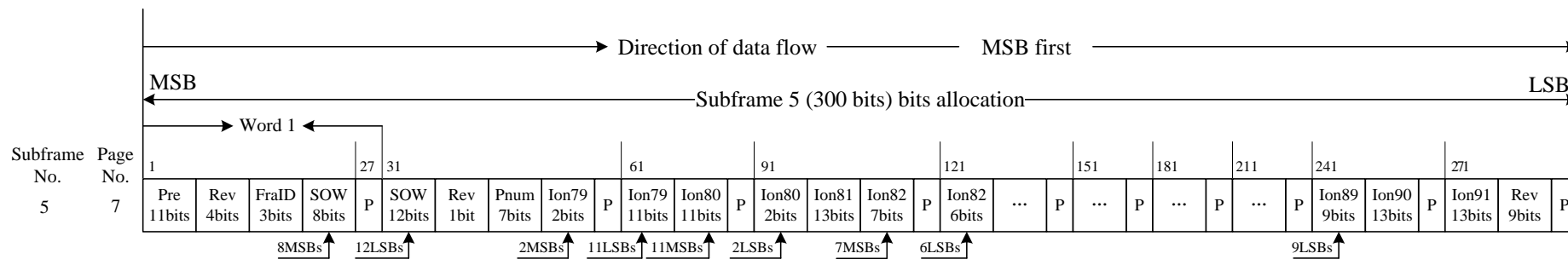

Figure 5-18-13 Bit allocation for page 7 of subframe 5 in format D2

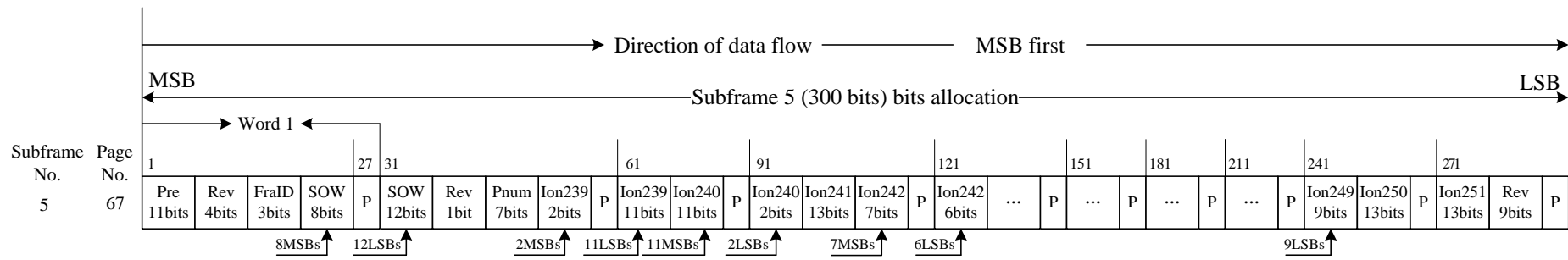

Figure 5-18-14 Bit allocation for page 67 of subframe 5 in format D2

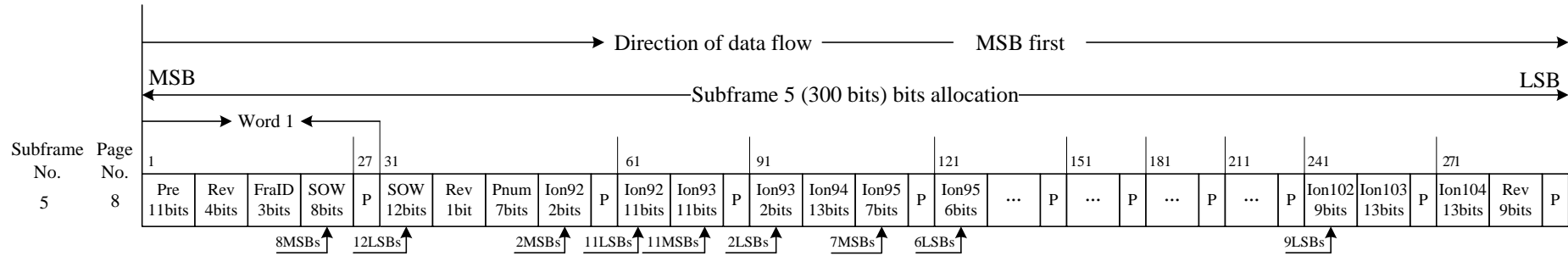

Figure 5-18-15 Bit allocation for page 8 of subframe 5 in format D2

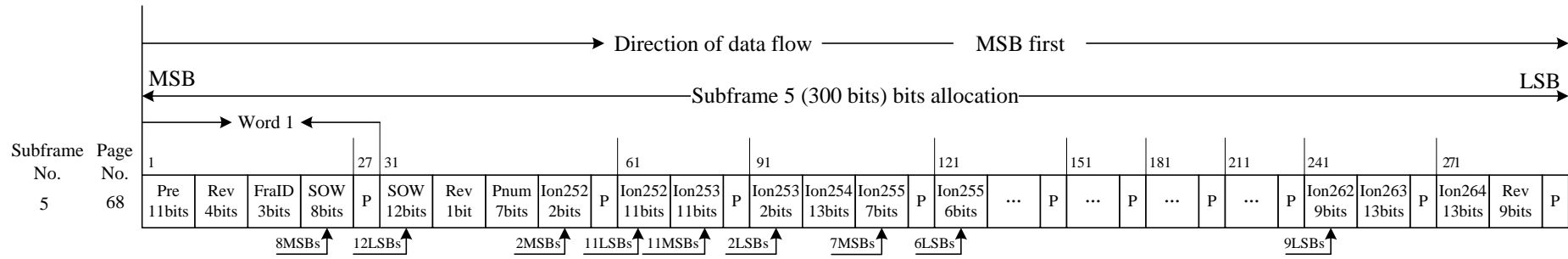

Figure 5-18-16 Bit allocation for page 68 of subframe 5 in format D2

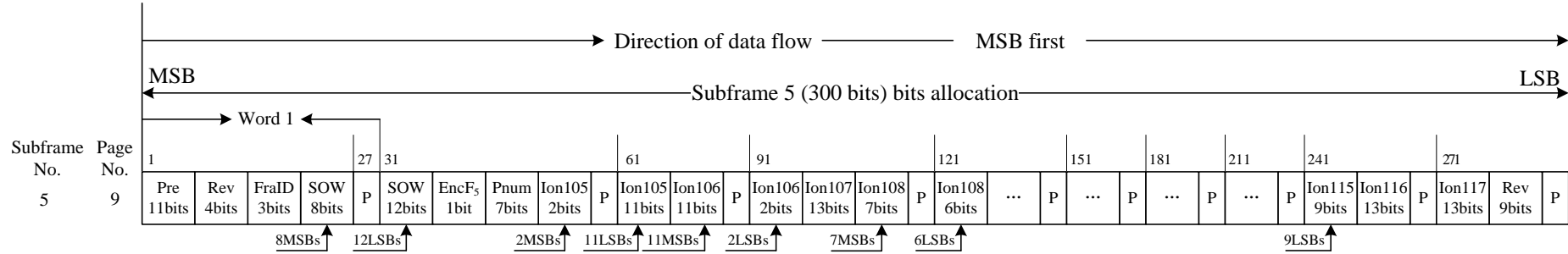

Figure 5-18-17 Bit allocation for page 9 of subframe 5 in format D2

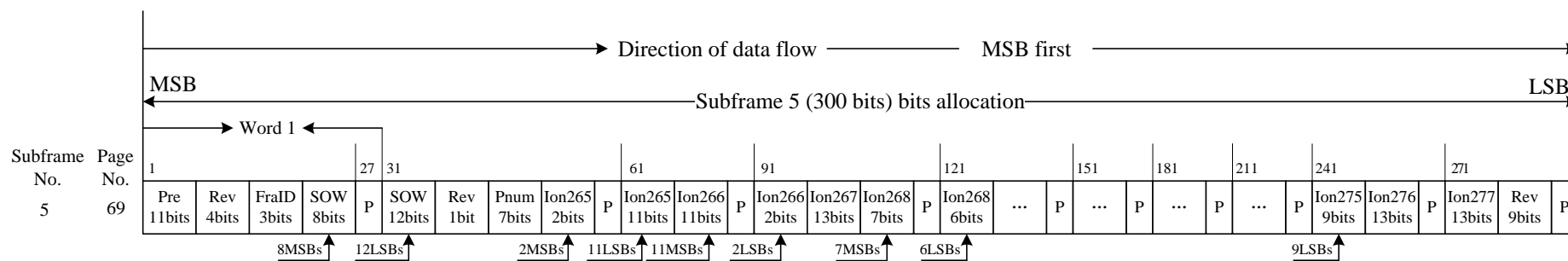

Figure 5-18-18 Bit allocation for page 69 of subframe 5 in format D2

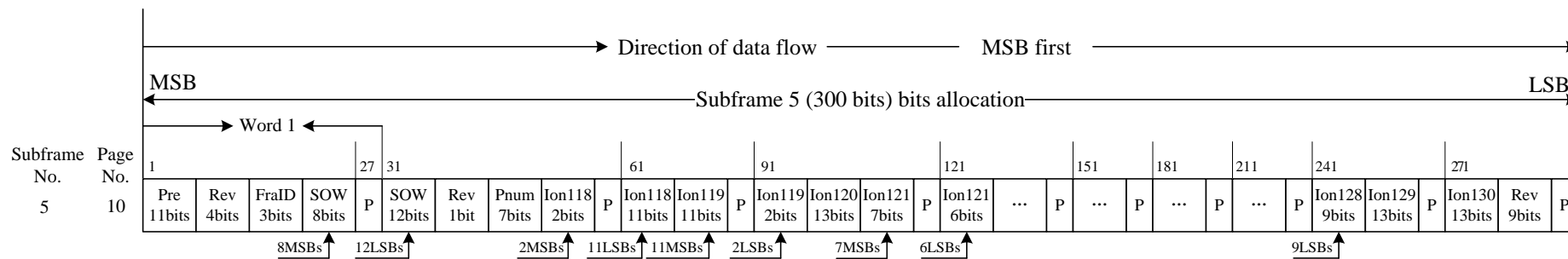

Figure 5-18-19 Bit allocation for page 10 of subframe 5 in format D2

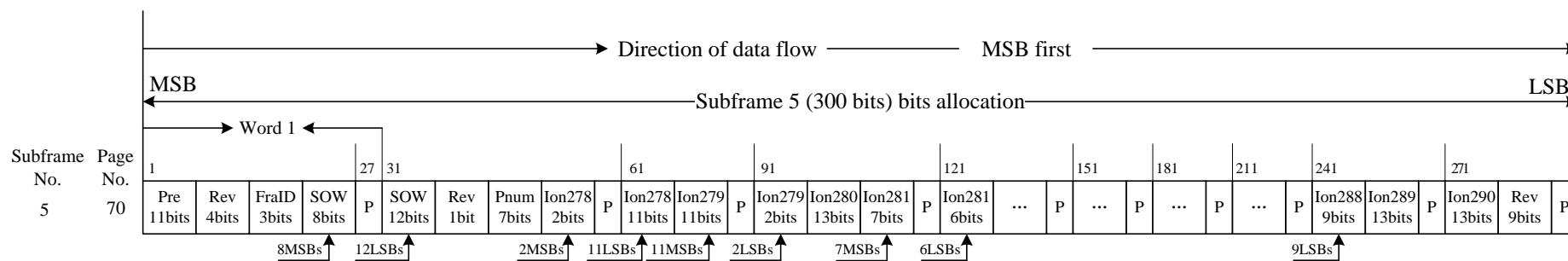

Figure 5-18-20 Bit allocation for page 70 of subframe 5 in format D2

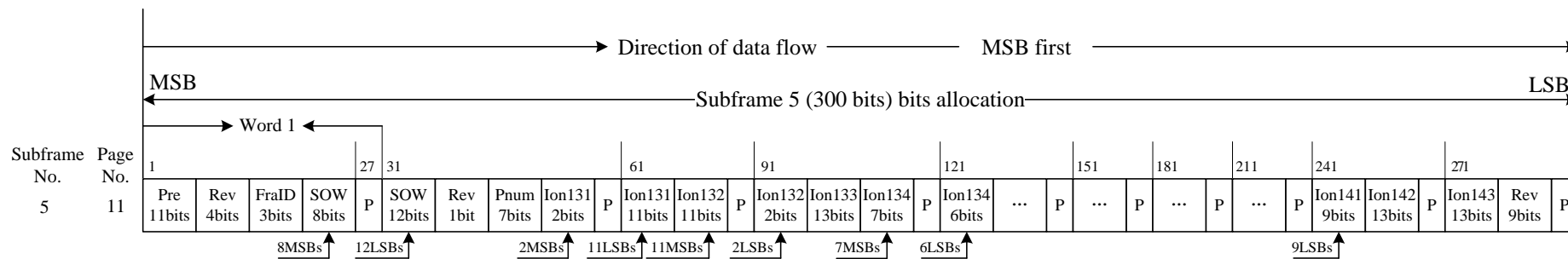

Figure 5-18-21 Bit allocation for page 11 of subframe 5 in format D2

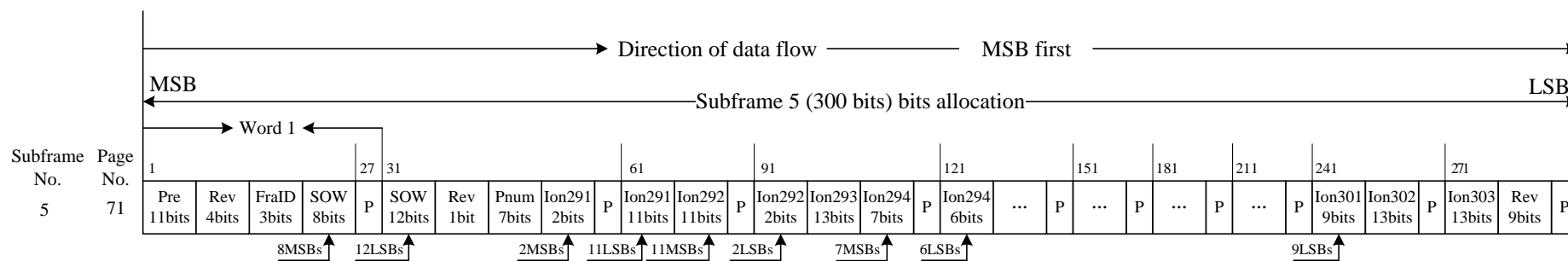

Figure 5-18-22 Bit allocation for page 71 of subframe 5 in format D2

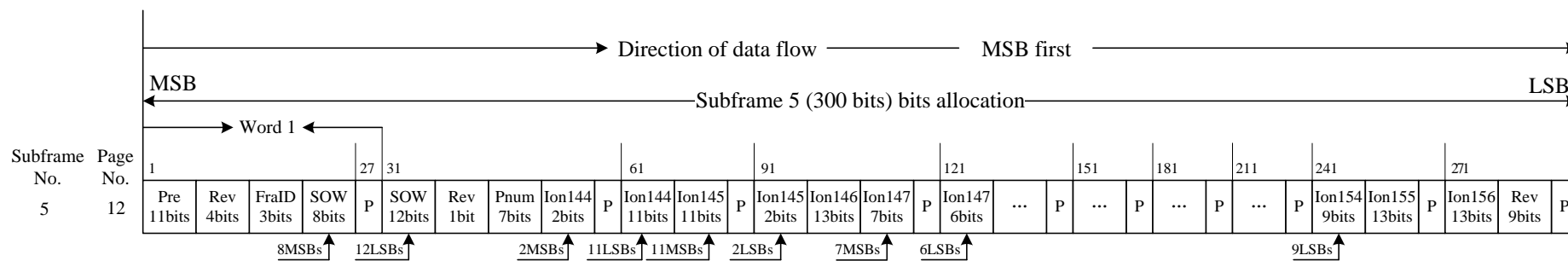

Figure 5-18-23 Bit allocation for page 12 of subframe 5 in format D2

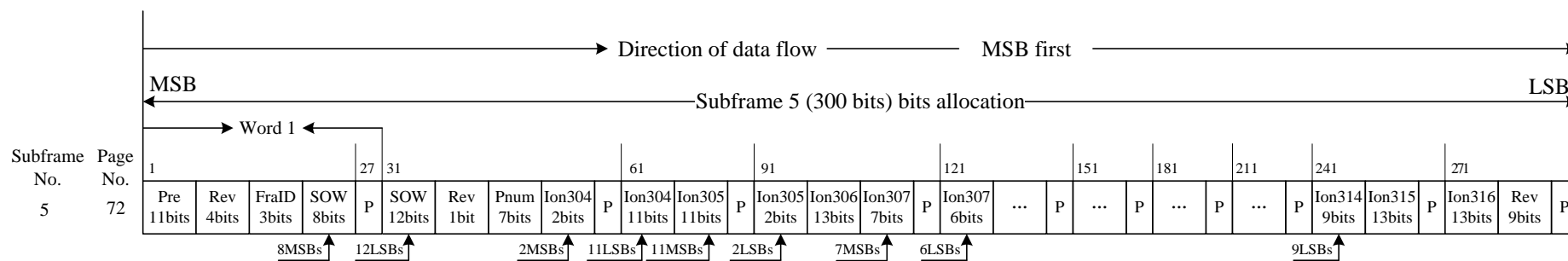

Figure 5-18-24 Bit allocation for page 72 of subframe 5 in format D2

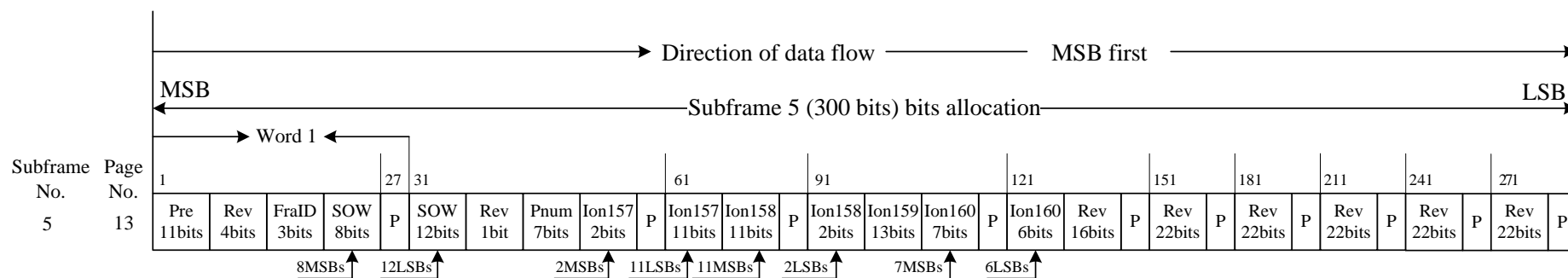

Figure 5-18-25 Bit allocation for page 13 of subframe 5 in format D2

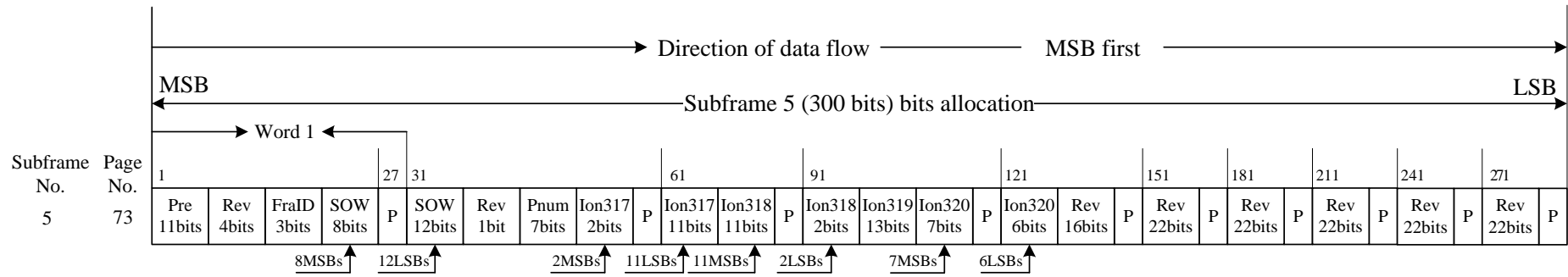

Figure 5-18-26 Bit allocation for page 73 of subframe 5 in format D2

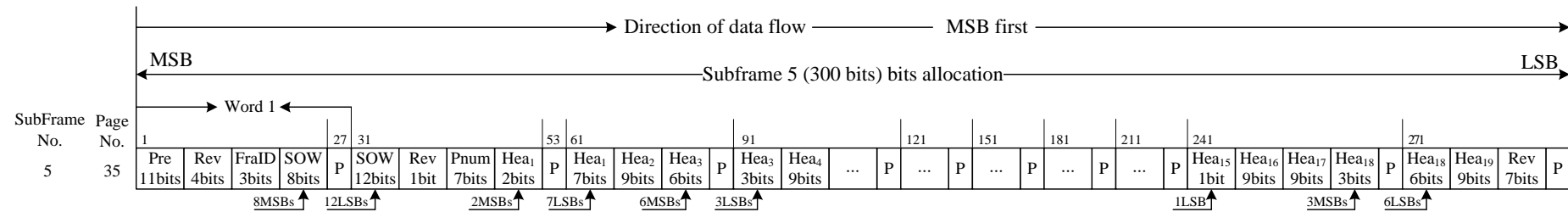

Figure 5-18-27 Bit allocation for page 35 of subframe 5 in format D2

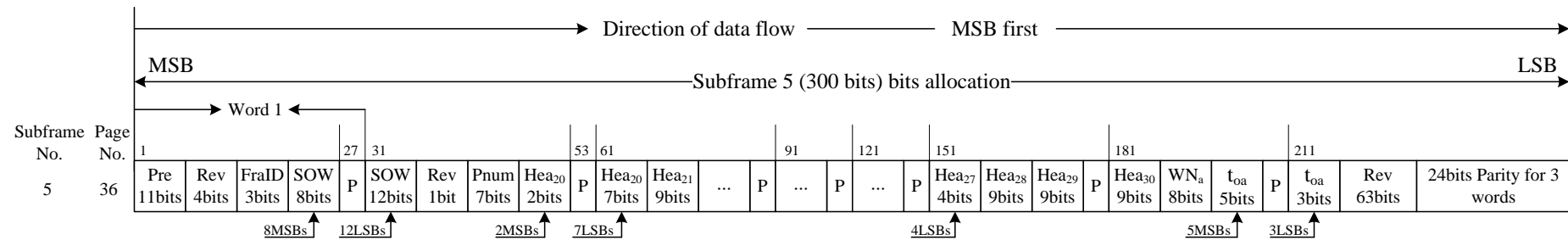

Figure 5-18-28 Bit allocation for page 36 of subframe 5 in format D2

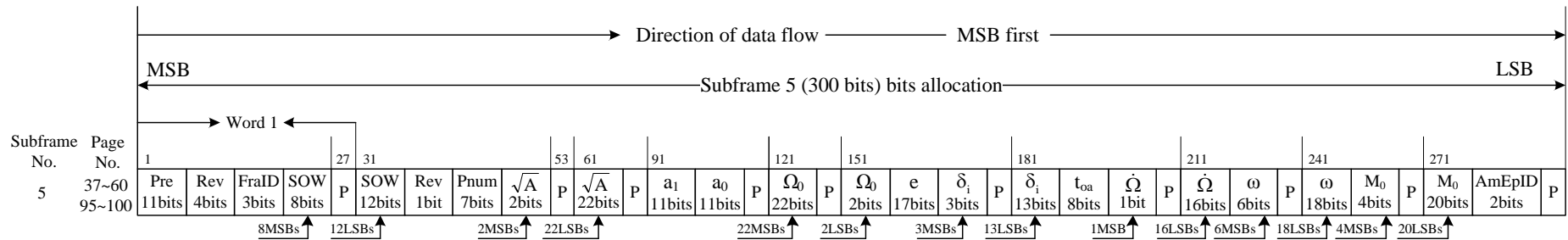

Figure 5-18-29 Bit allocation for pages 37 through 60 and pages 95 through 100 of subframe 5 in format D2

(Note: AmEpID is the identification of expanded almanacs in format D2, and its specific definitions are given in section 5.3.3.1)

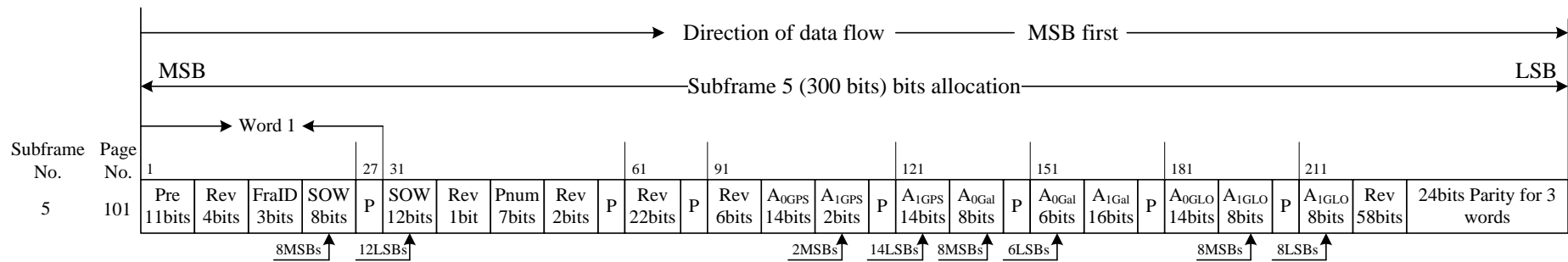

Figure 5-18-30 Bit allocation for page 101 of subframe 5 in format D2

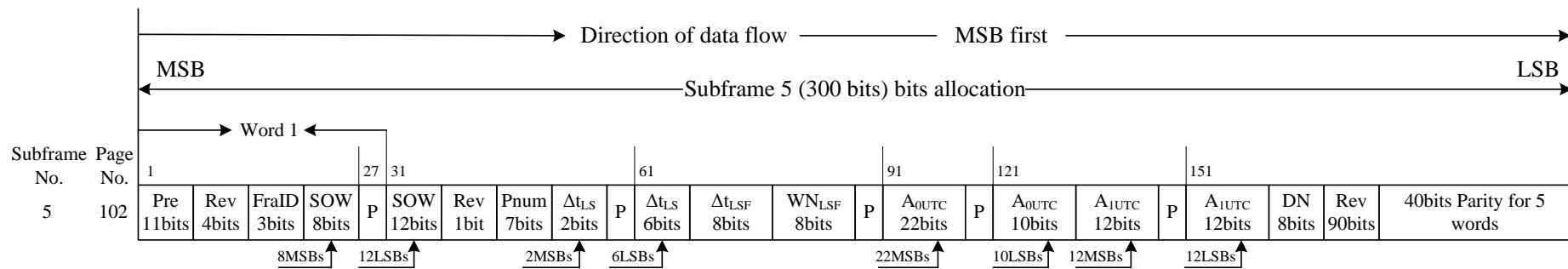

Figure 5-18-31 Bit allocation for page 102 of subframe 5 in format D2

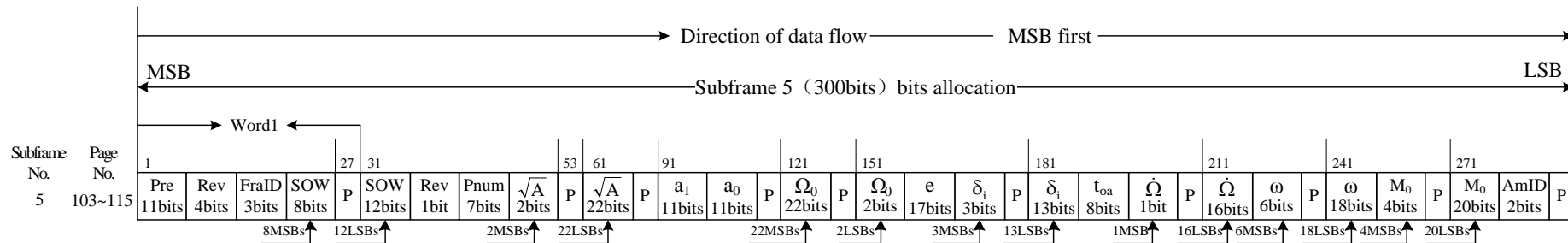

Figure 5-18-32 Bit allocation for pages 103 through 115 of subframe 5 in format D2

(Note: When AmEpID is equal to “11”, pages 103 through 115 of subframe 5 are used to broadcast the almanac parameters. Otherwise, pages 103 through 115 of subframe 5 are defined as reserved pages, i.e., bits 51 through 300 of these pages are reserved.)

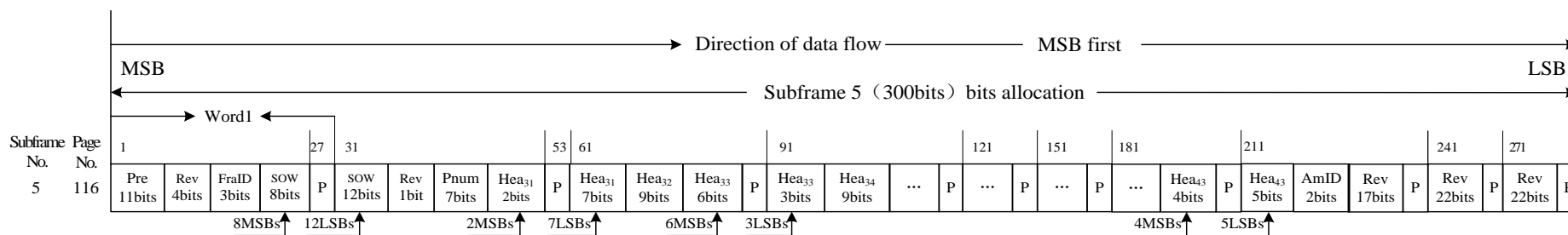

Figure 5-18-33 Bit allocation for page 116 of subframe 5 in format D2

(Note: When AmEpID is equal to “11”, page 116 of subframe 5 is used to broadcast the satellite health information. Otherwise, page 116 of subframe 5 is defined as a reserved page, i.e., bits 51 through 300 of this page are reserved.)

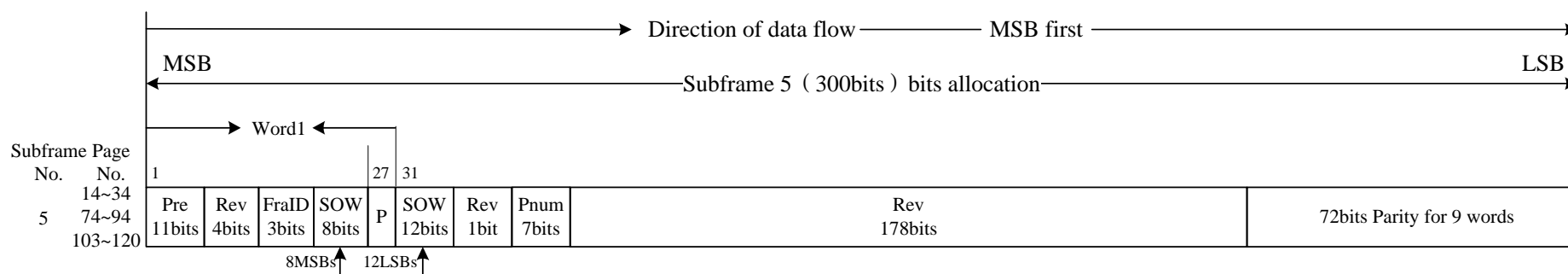

Figure 5-18-34 Bit allocation for reserved pages 14 through 34, 74 through 94, and 117 through 120 of subframe 5 in format D2

5.3.3 D2 Navigation Message Content and Algorithm

D2 navigation message contains basic navigation information and wide area differential information.

5.3.3.1 Basic Navigation Information

D2 navigation message contains all the basic navigation information as follows:

Fundamental navigation information of the broadcasting satellite:

- Preamble (Pre)
- Subframe identification (FraID)
- Seconds of week (SOW)
- Week number (WN)
- User range accuracy index (URAI)
- Autonomous satellite health flag (SatHl)
- Ionospheric delay model parameters ($\alpha_n, \beta_n, n=0\sim3$)
- Equipment group delay differential (T_{GD1}, T_{GD2})
- Age of data, clock (AODC)
- Clock correction parameters (t_{oc}, a_0, a_1, a_2)
- Age of data, ephemeris (AODE)
- Ephemeris parameters ($t_{oe}, \sqrt{A}, e, \omega, \Delta n, M_0, \Omega_0, \dot{\Omega}, i_0, IDOT, C_{uc},$

$C_{us}, C_{rc}, C_{rs}, C_{ic}, C_{is}$)

Page number (Pnum)

Almanac information:

- Identification of expanded almanacs (AmEpID)
- Almanac parameters ($t_{oa}, \sqrt{A}, e, \omega, M_0, \Omega_0, \dot{\Omega}, \delta_i, a_0, a_1, AmID$)
- Almanac week number (WN_a)
- Satellite health information ($Hea_i, i=1\sim43$)

Time offsets from other systems:

- Time parameters relative to UTC (A_{0UTC} , A_{1UTC} , Δt_{LS} , WN_{LSF} , DN , Δt_{LSF})
- Time parameters relative to GPS time (A_{0GPS} , A_{1GPS})
- Time parameters relative to Galileo time (A_{0Gal} , A_{1Gal})
- Time parameters relative to GLONASS time (A_{0GLO} , A_{1GLO})

The definition of basic navigation information is the same as that in format D1, except the page number (Pnum), seconds of week (SOW), identification of expanded almanacs (AmEpID), and identification of time-sharing broadcasting (AmID) which are different from those in format D1. Thus only the meanings of Pnum, SOW, AmEpID, and AmID are given as follows.

(1) Page number (Pnum)

In format D2, the information of subframe 5 is broadcast via 120 pages and the page number is identified by Pnum.

(2) Seconds of week (SOW)

In format D2, bits 19 through 26 and bits 31 through 42, altogether 20 bits of every subframe are for the seconds of week (SOW). SOW count starts from zero at 00:00:00 of BDT on every Sunday.

In format D2, SOW refers to the leading edge of preamble first bit in subframe 1 of each frame.

(3) Identification of expanded almanacs (AmEpID)

In format D2, AmEpID is the identification of the expanded almanac information, which has a length of 2 bits. AmEpID is provided to detect whether pages 103 through 116 of subframe 5 are used to broadcast the expanded almanac information (i.e., the almanac parameters and the satellite health information of SV ID 31 through 63).

When AmEpID is equal to “11”, pages 103 through 115 of subframe 5 can be used to broadcast the almanac parameters for SV ID 31 through 63, and page

116 of subframe 5 is used to broadcast the satellite health information for SV ID 31 through 63. Otherwise, pages 103 through 116 of subframe 5 are reserved.

(4) Identification of time-sharing broadcasting (AmID)

In format D2, AmID has a length of 2 bits, and its value is effective when AmEpID is equal to “11”. AmID can be used to identify the expanded almanac information (i.e., the almanac parameters and the satellite health information of SV ID 31 through 63) which are time-sharing broadcasted in pages 103 through 116 of subframe 5.

The user shall use AmEpID first to determine whether pages 103 through 116 of subframe 5 are used to broadcast the expanded almanac information. When AmEpID is equal to “11”, the user shall further use AmID to identify the expanded almanac information of SV ID 31 through 63 in pages 103 through 116 of subframe 5; otherwise, the value of AmID is invalid and the user shall not use pages 103 through 116 of subframe 5.

For format D2, The broadcasting scheme for the almanac parameters of SV ID 31 through 63 is defined in Table 5-22. The broadcasting scheme for the satellite health information is the same as the scheme for the satellite health information in D1 navigation message, which can refer to Table 5-17.

Table 5-22 Broadcasting scheme for the almanac parameters of SV ID 31~63

AmEpID	AmID	Pnum	SV ID
11	01	103~115	31~43
	10	103~115	44~56
	11	103~109	57~63
		110~115	Reserved
	00	103~115	Reserved

5.3.3.2 Page Number for Basic Navigation Information (Pnum1)

Bits 43 through 46, altogether 4 bits of subframe 1 are for page number of the basic navigation information (Pnum1). Pnum1 is broadcast in pages 1 through 10 of subframe 1.

5.3.3.3 Page Number for Integrity and Differential Correction Information (Pnum2)

Bits 44 through 47, altogether 4 bits of the subframe 2 are for the page number of the integrity and differential correction information (Pnum2). Pnum2 are broadcast in pages 1 through 6 of subframe 2.

5.3.3.4 Satellite Health Flag for Integrity and Differential Correction Information (SatH2)

The satellite health flag for integrity and differential correction information SatH2 is in 2 bits. The MSB indicates the check result of the satellite for the received up-link regional user range accuracy (RURA), user differential range error (UDRE) and equivalent clock correction (Δt). The LSB indicates the check result of the satellite for received up-link ionospheric grid information.

See Table 5-23 for detailed definitions.

Table 5-23 SatH2 definitions

Bit allocation	Code	Definition of SatH2
MSB	0	RURA, UDRE and Δt are good by check
	1	RURA, UDRE and Δt are bad by check
LBS	0	Ionospheric grid information is good by check
	1	Ionospheric grid information is bad by check

5.3.3.5 Identification of Expanded BDS Integrity and differential correction information (BDEpID)

BDEpID, which has a length of 2 bits, is provided to identify whether pages 1 through 6 of subframe 4 are used to broadcast the expanded BDS integrity and differential correction information.

When BDEpID is equal to “11”, pages 1 through 6 of subframe 4 can be used to broadcast the BDS satellite identification of integrity and differential correction information ($BDID_i$, $i=31\sim63$), regional user range accuracy (RURA), equivalent clock correction (Δt), and user differential range error index (UDREI). Otherwise, pages 1 through 6 of subframe 4 do not contain the BDS integrity and differential correction information and the user shall not use these pages and the corresponding bits are reserved.

5.3.3.6 BDS Satellite Identification of Integrity and differential correction information ($BDID_i$)

The BDS satellite identification of integrity and differential correction information ($BDID_i$, $i=1\sim63$) is in 63 bits to identify BDS satellites for which the integrity and differential information are broadcast. Every bit identifies one satellite. “1” means the integrity and differential correction information for the satellite are broadcast and “0” means not.

$BDID_i$ ($i=1\sim30$) are broadcast in subframe 2. $BDID_i$, ($i=31\sim63$) are broadcast in subframe 4.

BDS Integrity and differential correction information are allocated in ascending order of the SV ID.

5.3.3.7 BDS Regional User Range Accuracy Index (RURAI)

Regional user range accuracy (RURA) (i.e., BDS satellite signal integrity

information) is used to describe the satellite signal pseudo-range error in meters. RURA is indicated by the regional user range accuracy index (RURAI). Each RURAI occupies 4 bits, so its effective range is 0 to 15. The update period of RURAI is 18 seconds. Each RURAI broadcasted on the B1I signal indicates the integrity for the B1I signal of a given satellite. The corresponding relationship between RURAI and RURA is shown in Table 5-24.

Table 5-24 RURAI definitions

RURAI	RURA (meters, 99.9%)
0	0.75
1	1.0
2	1.25
3	1.75
4	2.25
5	3.0
6	3.75
7	4.5
8	5.25
9	6.0
10	7.5
11	15.0
12	50.0
13	150.0
14	300.0
15	> 300.0

Regional user range accuracy index (RURAI) is broadcast in pages 1 through 6 of subframe 2, subframe 3, and subframe 4. Thereinto, pages 1 through 6 of subframe 4 are used to broadcast the expanded information.

5.3.3.8 BDS Differential Correction and Differential Correction Integrity Information (Δt , UDREI)

5.3.3.8.1 Equivalent Clock Correction (Δt)

The BDS differential correction information is expressed as the equivalent clock correction (Δt). Each Δt for a given satellite is a signed, two's complement integer which occupies 13 bits, and its quantitative unit is 0.1 m. The update period of Δt is 18 seconds.

Each Δt broadcasted on the B1I signal indicates the differential correction information for the B1I signal of a given satellite. Δt is not available if the value is -4096. The user shall correct the residual error of the satellite clock offset and ephemeris by adding Δt to the observed pseudorange.

Equivalent clock correction (Δt) is broadcast in pages 1 through 6 of subframe 2, subframe 3, and subframe 4. Thereinto, pages 1 through 6 of subframe 4 are used to broadcast the expanded information.

5.3.3.8.2 User Differential Range Error Index (UDREI)

User differential range error (UDRE) (i.e., BDS differential correction integrity) is used to describe the error of equivalent clock correction in meters. UDRE is indicated by the user differential range error index (UDREI). Each UDREI occupies 4 bits, so its effective range is 0 to 15. The update period of UDREI is 3 seconds. Each UDREI broadcasted on the B1I signal indicates the differential correction integrity for the B1I signal of a given satellite. The corresponding relationship between UDREI and UDRE is shown in Table 5-25.

Table 5-25 UDREI definitions

UDREI	UDRE (meters, 99.9%)
0	1.0
1	1.5
2	2.0

3	3.0
4	4.0
5	5.0
6	6.0
7	8.0
8	10.0
9	15.0
10	20.0
11	50.0
12	100.0
13	150.0
14	Not monitored
15	Not available

User differential range error index (UDREI) is broadcast in pages 1 through 6 of subframe 2 and subframe 4. Thereinto, pages 1 through 6 of subframe 4 are used to broadcast the expanded information.

5.3.3.9 Ionospheric Grid Information (Ion)

The information about each ionospheric grid point (Ion) consists of the vertical delay at grid point ($d\tau$) and its error index (GIVEI), occupying 13 bits altogether. The data arrangement and definitions are as follows.

Table 5-26 Ion definitions

Parameter	$d\tau$	GIVEI
No. of bits	9	4

The ionospheric grid covers 70 to 145 degrees east longitude and 7.5 to 55 degrees north latitude. This area is divided into 320 grids of 5×2.5 degrees. The definition of ionospheric grid point (IGP) numbers less than or equal to 160 is listed in Table 5-27-1. Pages 1 through 13 broadcast ionospheric grid correction information according to this table.

Table 5-27-1 IGP numbers

E-Log. N-Lat.	70	75	80	85	90	95	100	105	110	115	120	125	130	135	140	145
55	10	20	30	40	50	60	70	80	90	100	110	120	130	140	150	160
50	9	19	29	39	49	59	69	79	89	99	109	119	129	139	149	159
45	8	18	28	38	48	58	68	78	88	98	108	118	128	138	148	158
40	7	17	27	37	47	57	67	77	87	97	107	117	127	137	147	157
35	6	16	26	36	46	56	66	76	86	96	106	116	126	136	146	156
30	5	15	25	35	45	55	65	75	85	95	105	115	125	135	145	155
25	4	14	24	34	44	54	64	74	84	94	104	114	124	134	144	154
20	3	13	23	33	43	53	63	73	83	93	103	113	123	133	143	153
15	2	12	22	32	42	52	62	72	82	92	102	112	122	132	142	152
10	1	11	21	31	41	51	61	71	81	91	101	111	121	131	141	151

When $IGP \leq 160$, the corresponding longitudes and latitudes are:

$$L = 70 + \text{INT}((IGP - 1)/10) \times 5$$

$$B = 5 + (IGP - \text{INT}((IGP - 1)/10) \times 10) \times 5$$

where, $\text{INT}(*)$ refers to round down.

The definition of ionospheric grid point (IGP) numbers more than 160 is shown in Table 5-27-2. Pages 60 through 73 broadcast grid ionospheric correction information according to this table.

Table 5-27-2 IGP numbers

E-Log. N-Lat.	70	75	80	85	90	95	100	105	110	115	120	125	130	135	140	145
52.5	170	180	190	200	210	220	230	240	250	260	270	280	290	300	310	320
47.5	169	179	189	199	209	219	229	239	249	259	269	279	289	299	309	319
42.5	168	178	188	198	208	218	228	238	248	258	268	278	288	298	308	318
37.5	167	177	187	197	207	217	227	237	247	257	267	277	287	297	307	317
32.5	166	176	186	196	206	216	226	236	246	256	266	276	286	296	306	316
27.5	165	175	185	195	205	215	225	235	245	255	265	275	285	295	305	315
22.5	164	174	184	194	204	214	224	234	244	254	264	274	284	294	304	314
17.5	163	173	183	193	203	213	223	233	243	253	263	273	283	293	303	313
12.5	162	172	182	192	202	212	222	232	242	252	262	272	282	292	302	312
7.5	161	171	181	191	201	211	221	231	241	251	261	271	281	291	301	311

When $IGP > 160$, the corresponding longitudes and latitudes are:

$$L = 70 + \text{INT}((IGP - 161)/10) \times 5$$

$$B = 2.5 + (IGP - 160 - \text{INT}((IGP - 161)/10) \times 10) \times 5$$

where, $\text{INT}(*)$ refers to round down.

5.3.3.9.1 Vertical Delay at Ionospheric Grid Points ($d\tau$)

$d\tau_i$ is the vertical ionosphere delay on B1I signal at the i^{th} grid point, expressed in scale factor of 0.125 and with unit of meters. The effective range of $d\tau_i$ is between 0 to 63.625 meters. IGP is not monitored when the $d\tau_i$ is 111111110 (=63.750meters) and vertical ionosphere delay is not available when the $d\tau_i$ is 111111111 (=63.875meters).

Making use of the ionospheric correction at grid points, the users compute the ionospheric correction for the intersection point of ionosphere and direction from user to observed satellite by interpolation and add it to the observed pseudo-range. The reference altitude of ionosphere is 375 km.

5.3.3.9.2 Grid Ionospheric Vertical Error Index (GIVEI)

The grid ionosphere vertical error (GIVE) describes the delay correction accuracy at ionosphere grid points and is indicated with GIVEI. See Table 5-28 for the relationship between GIVEI and GIVE.

Table 5-28 GIVEI definitions

GIVEI	GIVE (meters, 99.9%)
0	0.3
1	0.6
2	0.9
3	1.2
4	1.5
5	1.8
6	2.1

7	2.4
8	2.7
9	3.0
10	3.6
11	4.5
12	6.0
13	9.0
14	15.0
15	45.0

5.3.3.9.3 Suggestions on User Grid Ionospheric Correction Algorithm

The user can select effective data of the grid points adjacent to or nearby the observed intersection point with $d\tau_i$ and GIVEI to design the model and compute the delay correction for ionospheric pierce point (IPP) by interpolation. The guiding fitting algorithm for user grid ionospheric correction is given as follows:

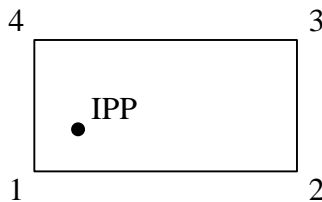

Figure 5-19 User IPP and Grid Points

Figure 5-19 illustrates the user IPP and its surrounding grid points. IPP, represented with geographic latitudes and longitudes as (ϕ_p, λ_p) , is the geographic location where the line-of-sight between the user and the satellite intersects with the ionospheric layer. The positions of the four surrounding grid points are represented with $(\phi_i, \lambda_i, i=1\sim 4)$ and the vertical ionospheric delays on the grid points are represented with $VTEC_i(i=1\sim 4)$ respectively. And $\omega_i(i=1\sim 4)$ shows the distance weight between IPP and the four grid points.

As long as there are at least three grid points surrounding the user IPP are

available and effective, the IPP ionospheric delay can be calculated from the vertical ionospheric delay of these effective grid points through the bilinear interpolation algorithm.

$$\text{Ionodelay}_p = \frac{\sum_{i=1}^4 \omega_i \cdot \text{VTEC}_i}{\sum_{i=1}^4 \omega_i}$$

where, $x_p = \frac{\lambda_p - \lambda_1}{\lambda_2 - \lambda_1}$, $y_p = \frac{\phi_p - \phi_1}{\phi_4 - \phi_1}$,

$$\omega_1 = (1 - x_p) \cdot (1 - y_p), \quad \omega_2 = x_p \cdot (1 - y_p), \quad \omega_3 = x_p \cdot y_p, \quad \omega_4 = (1 - x_p) \cdot y_p.$$

If any grid point of this observation epoch is marked as ineffective, its weight is zero.

6 Acronyms

AODC	Age of Data, Clock
AODE	Age of Data, Ephemeris
BDCS	BeiDou Coordinate System
BDS	BeiDou Navigation Satellite System
BDT	BeiDou Navigation Satellite System Time
bps	bits per second
BPSK	Binary Phase Shift Keying
CDMA	Code Division Multiple Access
CGCS2000	China Geodetic Coordinate System 2000
GEO	Geostationary Earth Orbit
GIVE	Grid point Ionospheric Vertical delay Error
GIVEI	Grid point Ionospheric Vertical delay Error Index
GLONASS	Global Navigation Satellite System
GPS	Global Positioning System
ICD	Interface Control Document
ID	Identification
IERS	International Earth Rotation and Reference Systems Service
IGP	Ionospheric Grid Point
IGSO	Inclined GeoSynchronous Orbit
IPP	Ionospheric Pierce Point
IRM	IERS Reference Meridian
IRP	IERS Reference Pole
LSB	Least Significant Bit
Mcps	Mega chips per second
MEO	Medium Earth Orbit
MSB	Most Significant Bit
NTSC	National Time Service Center
RHCP	Right-Hand Circular Polarization
RURA	Regional User Range Accuracy

RURAI	Regional User Range Accuracy Index
SOW	Seconds of Week
SV	Space Vehicle
UDRE	User Differential Range Error
UDREI	User Differential Range Error Index
URA	User Range Accuracy
URAI	User Range Accuracy Index
UTC	Universal Time Coordinated
WN	Week Number